

Effects of forest fires and clear-cutting on mercury loading to boreal lakes

Fabiola M. R. Pinheiro

**Department of Earth & Planetary Sciences
McGill University, Montreal
January, 2000**

A thesis submitted to the Faculty of Graduate Studies and Research in partial fulfillment of the requirements of the degree of Master of Science.

**© Fabiola M.R. Pinheiro
2000**



**National Library
of Canada**

**Acquisitions and
Bibliographic Services**

**395 Wellington Street
Ottawa ON K1A 0N4
Canada**

**Bibliothèque nationale
du Canada**

**Acquisitions et
services bibliographiques**

**395, rue Wellington
Ottawa ON K1A 0N4
Canada**

Your file Votre référence

Our file Notre référence

The author has granted a non-exclusive licence allowing the National Library of Canada to reproduce, loan, distribute or sell copies of this thesis in microform, paper or electronic formats.

The author retains ownership of the copyright in this thesis. Neither the thesis nor substantial extracts from it may be printed or otherwise reproduced without the author's permission.

L'auteur a accordé une licence non exclusive permettant à la Bibliothèque nationale du Canada de reproduire, prêter, distribuer ou vendre des copies de cette thèse sous la forme de microfiche/film, de reproduction sur papier ou sur format électronique.

L'auteur conserve la propriété du droit d'auteur qui protège cette thèse. Ni la thèse ni des extraits substantiels de celle-ci ne doivent être imprimés ou autrement reproduits sans son autorisation.

0-612-64431-6

Canada

ABSTRACT

Atmospheric mercury can be dispersed over long distances and eventually transferred onto land or water surfaces by wet and dry deposition. Absorbed by the vegetation, it later reaches the soil through litterfall. In the soil, mercury species are predominantly associated with particulate organic carbon (POC) and can be exported with surface runoff by erosion or in solution, associated with dissolved organic carbon (DOC). Terrestrial DOC, a by-product of POC decay, consists mostly of humic substances, which at high concentrations impart a brown color to waters. Inorganic mercury can be methylated under a variety of conditions, although low pH, low oxygen levels or slightly reducing conditions are most conducive to its formation. Methylmercury, the most toxic mercury species, is bioaccumulated and biomagnified along the aquatic trophic chain. This accounts for the high levels of mercury in fish, occasionally exceeding the recommended 0.5 mg/kg limit for human consumption (World Health Organization).

Clear-cutting (anthropogenic disturbance) and forest fires (natural disturbance) alter soil geochemistry and intensify surface runoff, thus increasing the export of organic carbon, nutrients and trace metals, both in the particulate and the dissolved phases. Water column samples collected in September 1997 and May 1998 from three treatment groups of lakes (9 whose watershed was clear-cut, 9 whose watershed was burnt, and 20 control lakes, whose watershed forests have not been touched by forest fires or clear-cutting for at least 70 years) were analyzed. Results of these analyses reveal a significant increase in the DOC and dissolved methylmercury concentrations in lake water after watershed clear-cutting. Following forest fires, there is an enrichment of methylmercury in the suspended particulate matter (SPM), as well as significant losses of nitrogen species. Thus, watershed perturbations increase the export of mercury species from the catchment to drainage lakes, and this effect is greater in logged- than in burnt-watershed lakes. This mercury export is dependent on the delivery of POC and DOC to the lakes, which increases as a result of surface runoff intensification.

RÉSUMÉ

Le mercure atmosphérique se disperse sur de longues distances et est éventuellement déposé à la surface du sol et des plans d'eau suite aux précipitations sèches et humides. Le mercure peut aussi atteindre le sol après son absorption par la végétation terrestre et son élimination sous la forme de débris. Le mercure du sol se trouve principalement associé au carbon organique particulaire (COP) et dissous (COD), pouvant être transporté avec l'écoulement de surface par érosion ou en solution. La plupart du COD terrestre est co-produit de la dégradation du COP et composé de substances humiques qui à de fortes concentrations sont responsables de la coloration marron des eaux. Quoique la méthylation du mercure inorganique puisse avoir lieu sous de conditions variables, un faible pH, une déficience en oxygène et les environnements légèrement reducteurs la favorisent. Le méthylmercure, l'espèce mercuriale la plus toxique, se bioaccumule et se biomagnifie tout au long de la chaîne trophique aquatique, ce qui explique les niveaux élevés en mercure mesurés dans les poissons. Ces niveaux sont parfois supérieurs à 0.5 mg/kg, le maximum recommandé par l'Organisation Mondiale de la Santé (OMS) pour la consommation humaine.

La coupe forestière (perturbation anthropogénique) et les feux de forêts (perturbation naturelle) modifient la géochimie du sol et intensifient l'écoulement de surface. Par conséquent, l'export particulaire et dissous de carbon organique, des nutriments et métaux-traces s'accroît. La colonne d'eau des lacs appartenant à trois groupes de traitement (9 lacs dont le bassin a été coupé, 9 lacs dont le bassin a été brûlé et 20 lacs de référence, dont le bassin n'a jamais été touché par le feu ou la coupe forestière pendant les derniers 70 ans au moins) a été échantillonnée en septembre 1997 et en mai 1998. L'analyse de ces échantillons a montré une augmentation significative des concentrations de COD et méthylmercure dissous dans les eaux des lacs après la coupe forestière. Les feux de forêts ont causé des pertes élevées des espèces azotées alors que le matériel particulaire en suspension s'est enrichi en méthylmercure. Ainsi, les perturbations font augmenter l'export d'espèces mercuriales du bassin aux lacs de drainage. Cet effet est beaucoup plus marqué pour les bassins coupés par rapport aux bassins brûlés. La quantité de mercure transféré dépend des concentrations de COD et COP, lesquelles s'augmentent avec l'intensification de l'écoulement de surface.

ACKNOWLEDGEMENTS

I wish to thank, first of all, my supervisor, Prof. Alfonso Mucci, for his guidance throughout the development of the project and for carefully reviewing this manuscript.

I am also indebted to the Department of Earth & Planetary Sciences, its staff and chair, Prof. Williams-Jones.

I must also acknowledge assistance received from the following: Vincent Cossa, for getting me started in methylmercury analysis; Constance Guignard, for help and instruction in the laboratory; Pete St.-Onge and Edenise Garcia, for kindly sharing material and information; Louise Courmoyer (GEOTOP-UQAM), for the carbon and nitrogen measurements; Dr. Bernardette Quémerais and Benoit Fortin (Centre Saint-Laurent), for the total mercury determinations; Pierre D'Arcy and Karine Gauthier (Université de Montréal), and Serge Paquet (GEOTOP-UQAM), for information provided; Prof. Dolores Planas, for her useful comments and participation as a committee member; Prof. Jacob Kalff, for his limnological input and suggestions.

Thanks to my laboratory and office mates, especially Sam Alpay, for her encouragement and advice, and Peggy Varga, for 'squeeful' moments in the office. Also to Mônica Freitas for all her help.

My gratitude to my parents, Lidia and Sebastião Pinheiro, for their constant support, in spite of the distance. Also to Nena Munhós and Maria Luíza Dorneles, who passed away during the writing of this thesis.

TABLE OF CONTENTS

Abstract	i
Résumé	ii
Acknowledgements	iii
Table of contents	iv
List of figures	vii
List of tables	viii
I – INTRODUCTION	
1. Sustainable Forest Management (SFM)	1
2. The boreal forest, its disturbances, and their effects	1
2.1. Natural disturbance (Fire)	2
2.2. Anthropogenic disturbance (Clear-cutting)	7
2.3. Dissolved organic carbon (DOC)	10
3. Mercury and methylmercury in the environment	13
3.1. Sources	13
3.2. Mercury in the atmosphere: emission, dispersion and scavenging	15
3.3. Atmospheric deposition as a source of mercury to watersheds	16
3.4. Mercury from the catchment: terrestrial inputs to lakes	17
3.5. The fate of mercury in lakes	18
3.6. Mercury concentrations in the environment	18
3.7. Methylmercury in the environment	20
3.8. The methylation process	20
4. Statement of the problem	22
5. Objectives	23
6. Working hypothesis	23
II – STUDY AREA	
1. Physical description of the area	24
2. Lake and catchment morphometry	24
2.1. Definition of morphometric terms	26
3. Experimental design	27

III – MATERIALS AND METHODS

1. Water column sampling for methylmercury analysis	28
2. Filter processing prior to methylmercury analysis on the SPM	29
3. Distillation of the water samples	29
4. Methylmercury analyses: water and SPM	33
5. Total mercury in the bottom sediments	37
6. Water chemistry	38
7. Statistical analysis	39
7.1. Among-group differences	39
7.2. Within-group differences	40

IV – RESULTS

A. Among-group differences

1. September 1997	41
1.1. Suspended particulate matter (SPM)	41
1.2. Methylmercury in the water samples	42
1.3. Dissolved organic carbon (DOC)	42
1.4. Other elements and ions	46
2. May	46
2.1. Methylmercury in the filtered water samples	46
2.2. DOC	47
2.3. Other elements and ions	47
3. Total mercury in the sediments recovered in July 1997	50

B. Within-group differences

1. Morphometric parameters	50
1.1. Methylmercury in the SPM	50
1.2. Dissolved MeHg concentrations in lake water column (May 1998)	51
1.3. Total mercury in the surficial bottom sediments	51
2. Lake water chemical parameters	52

V – DISCUSSION	
1. Suspended particulate matter (SPM)	54
2. C/N ratios	56
3. Dissolved organic carbon (DOC)	60
4. Methylmercury in the water column	63
4.1. Associated export of methylmercury and DOC	63
4.2. Stimulated methylation	65
4.3. Partitioning of methylmercury with DOC	66
5. Total mercury in the sediments	67
6. Chemical response delay	69
7. Lake and catchment morphometry	69
7.1. Correlations with methylmercury in the SPM	69
7.2. Correlations with dissolved methylmercury	70
7.3. Total mercury in the sediments	71
8. Lake water chemistry	71
VI – SUMMARY AND CONCLUSIONS	74
VII – BIBLIOGRAPHY	78
VIII – APPENDIX	103

LIST OF FIGURES

Figure II.1. Map of the study area	25
Figure III.1. Distillation system	31
Figure III.2. CVAFS analytical system	34
Figure IV.1. Concentrations of SPM in lake water column in September 1997	43
Figure IV.2. C/N molar ratios in the SPM in September 1997	43
Figure IV.3. Concentrations of MeHg in the SPM in September 1997	44
Figure IV.4. Concentrations of SPM according to depth in the water column of the stratified lakes in September 1997	44
Figure IV.5. Concentrations of MeHg in the SPM according to depth in the water column of the stratified lakes in September 1997	45
Figure IV.6. DOC concentrations in lake water column in September 1997	45
Figure IV.7. Dissolved MeHg concentrations in the water samples collected in May 1998	48
Figure IV.8. DOC concentrations in lake water column in May 1998	48
Figure IV.9. Total mercury concentrations in nmoles/g dry-weight in the bottom sediments recovered in July 1997	49
Figure IV.10. C/N molar ratios in the bottom sediments recovered in July 1997	49

LIST OF TABLES

Table II.1. Lake morphometric data for the logged (Cx) and burnt (FBPx or FPx) groups of lakes as of 1995	103
Table II.2. Catchment morphometric data for the logged (Cx) and burnt (FBPx or FPx) groups of lakes as of 1995	104
Table II.3. Morphometric data for the reference lakes as of 1995	105
Table II.4. Morphometric data for the reference lake catchments as of 1995	106
Table II.5. Percent of the watersheds logged in 1995	107
Table II.6. Percent of the watersheds burnt in 1995	107
Table II.7. Percent of the forested watersheds logged as of May 1998	108
Table IV.1. Abundance, C/N molar ratios, and MeHg contents of SPM collected in September 1997 at one or two depths in the lakes of the logged group	109
Table IV.2. Abundance, C/N molar ratios, and MeHg contents of SPM collected in September 1997 at one or two depths in the lakes of the burnt group	110
Table IV.3. Abundance, C/N molar ratios, and MeHg contents of SPM collected in September 1997 at one or two depths in the reference lakes	111
Table IV.4. Dissolved MeHg concentrations (pmole/l) in unfiltered and filtered water column samples collected in September 1997	112
Table IV.5. DOC concentrations in mg/l in lake water column samples collected in September 1997	113
Table IV.6. Chemical parameters – means and their standard errors (shown in parentheses) – of the water samples collected in September 1997	114
Table IV.7. Dissolved MeHg concentrations in filtered water samples of May 1998	115
Table IV.8. DOC concentrations in mg/l in lake water column samples collected in May 1998	116
Table IV.9. Chemical parameters – means and their standard errors (shown in parentheses) – of the water samples collected in May 1998	117
Table IV.10. Total mercury concentrations (nmole/g dw) and C/N molar ratios of the surficial bottom sediments collected in the logged and burnt groups of lakes in July 1997	118

Table IV.11. Total mercury concentrations (nmole/g dw) and C/N molar ratios of the surficial bottom sediments collected in the reference lakes in July 1997	119
Table IV.12. Pearson's determination coefficients (r) between the concentrations of MeHg in the SPM sampled in September 1997 and morphometric parameters	120
Table IV.13. Pearson's determination coefficients (r) between morphometric parameters and the concentrations of dissolved MeHg in the water sampled in May 1998	121
Table IV.14. Pearson's determination coefficients (r) between morphometric parameters and the concentrations of total Hg in the bottom sediments sampled in July 1997	122
Table IV.15. Pearson's determination coefficients (r) between the dissolved MeHg concentrations and chemical parameters in the water column sampled in May 1998	123
Table V.1: Partition coefficients (K_d) of MeHg between the SPM and the dissolved phase (i.e., <0.3 μm) for seven lakes sampled in September 1997	124

I – INTRODUCTION

1. Sustainable Forest Management (SFM)

This study is a component of the Sustainable Forest Management Network of Centres of Excellence (SFM-NCE) program, established in 1995 with the primary goal of developing and transferring technologies for the sustainable management of the Canadian boreal forest. The SFM-NCE defines sustainable forest management practices as those that maintain and enhance the long-term health of forest ecosystems, while providing environmental, economic, social, and cultural opportunities for the benefit of present and future generations.

In Canada, forest management has been changing, as the production of an optimum mix of commodities and services from the forest is no longer the only goal. According to the new principles of sustainable forest management, production is a by-product of a healthy ecosystem, and emphasis is given to the maintenance of the ecological integrity of the forest (Armstrong, 1998; McFarlane et al., 1998).

The concept of forest ecosystem management based on natural disturbance has generated a great deal of interest. This approach maintains stand composition and structures similar to those that characterize natural environments. This could provide a means of preserving biodiversity and the essential functions of forest ecosystems. In fact, silvicultural practices that emulate natural disturbances have been proposed for the principal vegetation zones of the Province of Quebec, where some are currently in use (Bergeron et al., 1998b).

2. The boreal forest, its disturbances, and their effects

In Canada, boreal forests extend from coast to coast and consist mostly of coniferous trees (Carleton and MacLellan, 1994). Low temperatures delay organic matter decomposition, thus favoring carbon preservation (Schlesinger, 1984). For this reason, boreal forests are the largest reservoir of terrestrial organic carbon of the Northern Hemisphere (Bonan and Shugart, 1989; Carleton and MacLellan, 1994), where they cover 11 percent of the total area (Bonan and Shugart, 1989; Carleton and MacLellan, 1994).

Millions of square kilometers of the Canadian boreal forests spontaneously burn

every year. In 1995 alone, fire affected more than 1600 square kilometers of forest and approximately 300 lakes in the regions of Gaspésie, Haute Mauricie, and Abitibi-Lac-Saint-Jean, in the Province of Quebec (CRFQ, 1995). In addition, the importance of forest harvesting, both in terms of the area it affects and its contribution to the economy, has increased over the past decades, to the point of subduing fire as the major disturbance agent (Brumelis and Carleton, 1988; Carleton and MacLellan, 1994; Ash, 1995).

However, despite the importance of forest fires and clear-cutting activities in Canadian forests, little information is available on the impacts of these two perturbations on DOC export (Moore, 1989) and trace metal mobilization, especially in the case of mercury and methylmercury. In order to achieve the goal of developing forest management techniques inspired by natural disturbances, it is necessary to have a thorough understanding of the impacts of both natural and anthropogenic interferences on forest environments.

Methods for analyzing and comparing the effects of forest fires and clear-cutting can be classified as intensive or extensive. The intensive approach requires detailed knowledge of the forest before the disturbance and direct observation or historical reconstruction of the recovery of the site after it is disturbed. The extensive approach, used in the present study, involves only post-disturbance information, analyzing the effects at the regional level and relating them to the characteristics of the area and other interactive influential factors (Foster, 1985; Brumelis and Carleton, 1988; Carleton and MacLellan, 1994).

2.1. Natural disturbance (Fire)

2.1.1. Nature and characteristics of forest fires

Since the last deglaciation, fire has been the most important non-anthropogenic factor determining the ecological structure of North-American forests. Fire can be held responsible for the species composition, age structure, successional stages, diversity, productivity, and stability of the vegetation and associated wildlife. Therefore, as fire affects the whole forest ecosystem, it can be considered a major landscape-building element (Heinselman, 1973; Kilgore, 1973; Engelmark et al., 1993; Armstrong, 1998).

Some forest areas have been intensively managed through harvesting and

reforestation or fire suppression (Heinselman, 1973). In spite of human intervention over the past century, which altered their frequency and severity, forest fires continue to be mostly a natural and recurrent phenomenon. Ignition is usually provided by lightning strikes, even though in the Canadian boreal forests there are only three to ten days of thunderstorms each year (Heinselman, 1973; Kilgore, 1973; Armstrong, 1998). Additionally, fires may occasionally start as a result of high temperature or volcanic activity (Heinselman, 1973; Kilgore, 1973), although these are not important in Canadian boreal forests.

Fires ignited by lightning are endogenous, i.e., they constitute an intrinsic process in the development of the ecosystem. These fires play an essential role in maintaining productivity at high levels and keeping the forest from stagnation and decay. By eliminating trees that are old or weakened by disease or parasites or that have been blown down by wind, endogenous fires rejuvenate the forest. At the same time, fires eliminate plant litter from the forest floor, decomposing the accumulated organic matter into nutrients and energy, a task that could not be performed by microorganisms alone. In fact, litter accumulation serves as the fuel for forest fires (Heinselman, 1973; Kilgore, 1973; Staaf and Berg, 1981; Engelmark et al., 1993; Attiwil, 1994b; Armstrong, 1998).

The formation of plant litter is the first step in the recycling of nutrients and energy from plants to soil. Litter production is a physiological process related to the age, growth pattern, metabolic function, and species structure of the vegetation. In old-growth stands, for instance, biomass usually declines over time, whereas the percentage of dying woody tissue increases. Litter formation depends as well on the development of undergrowth vegetation, since shrubs and ground vegetation may contribute significantly to the total amount of above-ground residue (Heinselman, 1973; Kilgore, 1973; Staaf and Berg, 1981).

The concepts of fire cycle and natural fire rotation are important in forest management, as they reflect the intensity of dynamic processes and the rate of renewal of the forest area. Fire cycle is defined as the time in years required for a specifically delimited forest area to burn. Natural fire rotation is defined as the number of years it takes for the area under consideration to burn and reproduce again. It expands the concept of fire cycle by including the regeneration phase. An evaluation of these two concepts,

even if merely approximative, permits comparison between forest ecosystems for scientific purposes. In the boreal forest, the natural fire cycle ranges from 26 to 500 years, and the natural fire rotation is obviously somewhat larger (Dansereau and Bergeron, 1991; Armstrong, 1998). Hence we can say that, without human interference, large extents of forest burn at rather long intervals, when conditions are made possible by a combination of climatic factors and fuel availability (Heinselman, 1973; Kilgore, 1973; Attiwil, 1994b; Dansereau and Bergeron, 1991; Armstrong, 1998).

2.1.2. Differences in fire onset and development

The characteristics and consequences of forest fires depend mainly on vegetation, physical landscape, weather, and fuel availability. Vegetation types differ as to their litter production and their flammability (Heinselman, 1973; Kilgore, 1973; Woodmansee and Wallach, 1981; van Wilgen and van Hensbergen, 1992). Physical landscape features such as lakes, streams, wetlands, bedrock ridges, valleys, and throughs may act as either firebreaks or firepaths (Heinselman, 1973). For instance, in wetland-rich lowland plains, fires are smaller and less frequent than in regions with elevations (Foster, 1983). When the landscape is free of water barriers such as lakes, fires are large and intense, although less frequent. On the other hand, if there are numerous water bodies as well as a rough topography, fires tend to occur with decreased intensity and extent, but with increased frequency. This is because the lack of uniformity renders continuous, intense fires practically impossible (Kilgore, 1973; Dansereau and Bergeron, 1991). Sub-alpine mountainous terrain acts as a firebreak, by preventing fire from spreading rapidly across the conifer forests (Kilgore, 1981). Physical landscape may also exert its influence through slope, soil, or ecological functions like productivity or diversity (Heinselman, 1973). Other elements, such as wind direction, and permeability and size of water barriers, help determine the role of water bodies in delimiting fires (Hunter, 1993).

Weather and fuel buildups are closely related and must be jointly explained. Spring and fall are favorable seasons for forest fires, as plant litter quickly accumulates onto the forest floor. This increased availability of fuel enables fires to start promptly, once ignition is provided, and to extend rapidly. Conversely, summer plant material is mostly green and absorbs heat. As a result, summer fires normally require more radical

climatic conditions in order to achieve spread rates and burning intensities similar to those of spring and fall fires (Heinselman, 1973). However, as the fire progresses, live plants dry until they begin to burn as well (van Wilgen and van Hensbergen, 1992). Such conditions are most commonly enabled by prolonged droughts, when evapotranspiration-dried litter and humic matter add to the fuel. The number of consecutive days without precipitation is strongly correlated with the area over which the fire spreads. The amount of precipitation is also significant in that strong rainfall may be sufficient to extinguish most fires. Spring and fall fires differ from one another in that, in the spring, moisture and frost present in soil, litter, and organic matter usually prevent the quick expansion and thorough consumption of fuels and soil organic layers (Heinselman, 1973).

The consequences of fire upon a forest environment largely depend on the frequency, duration, and intensity of the fire (Heinselman, 1973; Kilgore, 1973; Woodmansee and Wallach, 1981; Dansereau and Bergeron, 1991; Bergeron et al., 1998b). Fire intensity, i.e., its rate of energy release, may vary more than 1000-fold (Kilgore, 1973). Some fires, known as crown fires, are severe enough to eliminate a large number of trees. These trees will be replaced with the birth of new ones, which together will form an age class, a new stand whose year of origin traces back to the time the fire took place. Surface fires, on the other hand, affect only a few scattered trees and do not introduce new stands or age classes (Heinselman, 1973; Kilgore, 1973). Smaller fires are usually more frequent than large ones (Dansereau and Bergeron, 1991; Hunter, 1993), following the rule of inverse relationship between frequency and intensity of natural disturbances (Margalef, 1997).

According to intensity, fires can be classified into three categories:

- **Small to moderate:** e.g., surface fires in white and red pine stands, which do not burn the soil, but decrease the wood volumes;
- **Moderate:** e.g., fires of variable severity occurring in mixed forests and leaving a number of green forest island residuals;
- **Large:** e.g., high severity fires which take place in the coniferous boreal forest and burn soil organic layers (Bergeron et al., 1998b).

2.1.3. Impacts of fire on soil geochemistry

Fire intensity and the extent of humus layer consumption are the main determinants of the impacts of fire on the soil. Light burns often stimulate nitrification, elevate soil pH, and chemically improve soils by increasing the availability of phosphorus, potassium, calcium, and magnesium (Kilgore, 1973; Wells et al., 1979). On the other hand, intense fires may deplete nutrients, either through the volatilization of nitrogen and potassium or the leaching of water-soluble cations, organic ions and nitrate as a result of increased runoff. Independent of fire intensity, soil moisture contents tend to rise soon after burning and decline again as regeneration progresses with new trees growing and absorbing more water. The temporary rise in soil moisture levels leads to augmented surface runoff and erosion (Heinselman, 1973; Kilgore, 1973; Woodmansee and Wallach, 1981; Scott and van Wyk, 1992; van Wyk et al., 1992; van Reenen et al., 1992; Attiwil, 1994b; Bergeron et al., 1998b).

In nature, fire is the agent that periodically and efficiently consumes the accumulation of litter, humus, and peat and recycles the mineral elements and carbon contained in soils, controlling nutrient cycles and energy pathways. Most of the elements present in phytomass are physically mineralized and deposited on the soil surface with the ash that results from burning. Typically, microbial activity is enhanced after fire, due to increases in temperature, moisture, pH and availability of carbon and nutrients (Woodmansee and Wallach, 1981). Although bacterial populations increase, soil fungi usually decrease in number as a result of fire (Kilgore, 1973).

Although forest fires destroy biomass and a large amount of accumulated organic matter, their immediate effect on soil organic carbon contents is limited. Initially, all leaf material disappears, and a large proportion of charcoal, imperfectly burnt wood, and loose soil aggregates predominate, thus increasing the amount of aboveground residue. This residue progressively decomposes and disappears, as litter-fall accumulation and decay no longer balance the mineralization and eluviation processes. The result, then, is a decline in soil organic carbon, which usually persists for two years after fire-induced deforestation. As new trees establish and grow, litter input increases again, until a steady state is reached at canopy closure (Staaf and Berg, 1981). Simultaneously, leaching losses of chemical components are regulated and eventually prevented, as they also depend

largely on the rate of recovery of forest vegetation (van Wyk et al., 1992).

2.2. Anthropogenic disturbance (Clear-cutting)

The term clear-cutting involves complete felling of overstory and understory trees (Keenan and Kimmins, 1993), but it comprises different techniques of forest harvesting, and the spatial extent of forest removal (i.e., the size of the logged area) is highly variable. As to the harvesting technique, differences lie on the presence and intensity of mechanical site preparation, the extent of tree removal (whole trees or stems only), and the pre- and post-logging treatment of the site (Vitousek, 1981; Wiklander, 1981; Keenan and Kimmins, 1993).

Some of the consequences of forest clear-cutting in boreal ecosystems are similar to those of fires, namely the removal of the tree canopy and the microclimatic modifications at ground level and in the soil layers. However, the similarities are limited, as the abundance and structure of biomass left on clear-cuts has little in common with those of a burnt forest (Carleton and MacLellan, 1994; Bergeron et al., 1998a,b). Fire leaves some trees standing, dead or not, which accelerates the recolonization and regeneration of the forest. In contrast, clear-cutting removes the vegetation uniformly over large areal extents and leaves no seed banks and no standing trees to provide shade and protection to the soil or to seedlings that might eventually be established (Carleton and MacLellan, 1994).

2.2.1. Impacts of clear-cutting on hydrology

In forested areas, precipitation is partially or completely intercepted by vegetation before reaching the ground. The forest floor protects the soil from the direct impact of rainfall and reduces the incidence of overland flow (Thomas, 1975a,b; Keenan and Kimmins, 1993). Evapotranspiration and soil water movement are, together, the most important processes in the hydrologic cycle. The water infiltration rate is determined by soil porosity and water content, with the infiltration rate increasing as the water content decreases and the porosity increases. Porosity depends on the presence and depth of a duff layer (Thomas, 1975a,b) in the upper surface of the soil, right beneath the trees. Duff is the partially decayed organic matter layer found between the litter and the humus

(Ashwort, 1991). In forests possessing a deep, porous duff layer, infiltration rates are so high that virtually all rainfall penetrates the soil, and almost no surface runoff is observed (Thomas, 1975a,b).

During clear-cutting events, the duff layer is partially or completely removed, and the soil top layer may be compacted or mixed with the underlying mineral soil by machinery and logs (Thomas, 1975a; Groot, 1987; Ash, 1995; Jewett et al., 1995). In addition, soil water removal through evapotranspiration is prevented, since the vegetation cover is lost (Likens et al., 1970; Thomas, 1975a,b; Jewett et al., 1995), and soil water saturation may be attained. With the onset of saturation, water accumulates at the surface (Likens et al., 1970; Rothacher, 1970; Thomas, 1975a,b; Greacen and Sands, 1995; Jewett et al., 1995). This leads to intensified runoff and accelerated erosion and leaching of dissolved and particulate materials in soil, such as organic carbon, nitrogen and potassium (Rothacher, 1970; Brown et al., 1973; Thomas, 1975a,b; Hornbeck et al., 1986; Troendle and King, 1987; Fuller et al., 1988; Brais et al., 1995; Rosén et al., 1996; Berdén et al., 1997).

2.2.2. Impacts of clear-cutting on soil geochemistry

Besides producing a variety of physical, hydrological, and biological effects related to the removal of the vegetation cover, forest clear-cutting has been shown to impact forest soil geochemistry, by disrupting nutrient and carbon cycles (Brown et al., 1973; Boorman and Likens, 1979a; Fuller et al., 1988). It also affects the concentration and export of trace metals associated with organic matter and mineral phases (Fuller et al., 1988). This is a consequence of the enhanced mineralization of the forest floor, the weathering of exposed mineral surfaces, and the transport of particulate matter to streams and lakes (Brown et al., 1973; Fuller et al., 1988; Brais et al., 1995).

After a logging operation, large amounts of slash and other organic debris are left on the forest floor. Slash includes all portions of woody plants that are dead or dying as a result of tree harvesting (Brown et al., 1973; Moore, 1989; Ashwort, 1991). The decomposition of this material is accelerated by the microclimatic changes which follow clear-cutting (Moore, 1989; Brais et al., 1995). The decomposition products include particulate and dissolved organic matter, as well as nutrients, which are increasingly

leached from the forest floor with the intensified surface runoff (Schlesinger, 1984; Fuller et al, 1988).

According to Brais et al. (1995), the impact of clear-cutting on leaching losses of various elements depends on the specific mobilization and transport mechanisms of these elements. The concentrations of lead and iron in surface runoff depend on the retention or release of organic carbon by deeper mineral soils, as DOC (dissolved organic carbon) controls the solubility and transport of these two elements through organic complexation reactions. In contrast, manganese and zinc are actively leached after forest clear-cutting, regardless of the fate of DOC.

Nitrogen is mostly leached from the soil in the form of nitrate, which is produced in excess as a result of increased nitrification and reduced or absent nitrogen uptake by the vegetation. The excess nitrate formed is rapidly leached from the soil. Nevertheless, nitrogen-fixing microbes usually counterbalance this loss rapidly. Besides increasing the export of nitrogen, higher nitrification rates also affect sulfate retention and the leaching of base cations and the prevailing aluminum species (Berdén et al., 1997). Nonetheless, since the process of nitrification is strongly acidifying, the primary consequence of increased nitrification is the decline in soil pH (McCull, 1972; Brown et al., 1973; Fuller et al., 1988; Dahlgren and Driscoll, 1994; Brais et al, 1995). Two hydrogen ions (H^+) are produced for every ammonium ion (NH_4^+) nitrified, i.e., for each nitrate ion (NO_3^-) produced. We can represent the nitrification reaction as:



In undisturbed systems, the nitrate formed would be rapidly taken up by roots and reduced to NH_4^+ , resulting in no net acidification (Berdén et al., 1997). Other processes that can consume or produce protons, aside from nitrification, also contribute to soil acidification after clear-cutting (Brais et al., 1995). One of such processes is organic matter accumulation and decomposition (Binkley and Richter, 1987; Berdén et al., 1997; Keenan and Kimmins, 1993). A pH decline has been reported by several authors for periods ranging from 1 to 16 years after clear-cutting (Likens et al., 1970; Adams and Boyle, 1982; Krause, 1982; Mroz et al., 1985; Nykvist and Rosén, 1985; Johnson et al., 1991; Staaf and Olson, 1991; Dahlgren and Driscoll, 1994). The decline in soil pH has a double-sided effect on soil trace metal mobility. For most trace metals, solubility is

increased and leaching is facilitated at lower pH. However, for trace metals that are associated with organic solutes in the soil, mobility may decrease as a result of lower pH (Fuller et al, 1988).

Given that the speciation and toxicity of a given trace metal is closely related to pH, as well as to the behavior and fate of DOC and to several other chemical and physical factors, assessing the impact of forest clear-cutting on water quality and aquatic biota is a complex endeavor.

2.3. Dissolved organic carbon (DOC)

A much larger amount of carbon is held in soils than that in the atmosphere or vegetation (Woodwell, 1984). In forest soils, DOC is produced primarily from microbial activity, root exudates, and leaching of particulate organic matter from plant debris (Schlesinger, 1984; Schiff et al., 1997) and is mostly concentrated in the top soil layers, i.e., the O- and A- horizons. The progressive decrease in DOC concentrations as it is transported deeper into the soil profile is due to mineralization, adsorption, and precipitation processes (Buringh, 1984; Dmytriw et al., 1995; Kalbitz and Wennrich, 1998).

Once produced, DOC may be sorbed onto particles, infiltrated through the soil profile, decomposed, or exported from the forest catchment with surface runoff (Schlesinger, 1984; Verta et al., 1989; Aastrup et al., 1991; Mierle and Ingram, 1991; Lucotte et al., 1992; Pettersson et al., 1995; Schiff et al., 1997). Decomposition of DOC is possible at all stages of its cycling and ultimately leads to the loss of carbon to the atmosphere as carbon dioxide (Schlesinger, 1984; Woodwell, 1984; Fuller et al., 1988). Mineralization of DOC depends on environmental conditions and its composition, namely its carbon-to-nitrogen ratio (Schlesinger, 1984; Woodwell, 1984; Schiff et al., 1997). The lower the C/N ratio of the organic matter, i.e., the higher the nitrogen content relative to the carbon content, the greater its susceptibility to decomposition (Cole and Heil, 1981; Staaf and Berg, 1981).

Of the total annual loss of surficial forest floor material, 25 to 50 percent is in the form of DOC (Curtis and Schindler, 1997). Surface runoff can carry large amounts of organic material, not only dissolved, but also in suspension (Schlesinger, 1984; Verta et

al., 1989; Lucotte et al., 1992; Schiff et al., 1997). The amount of DOC exported depends on the characteristics of the local soil (Brown et al., 1973; Fuller et al., 1988) and climate, and on hydrologic changes affecting runoff. Under normal conditions, the export of terrestrial DOC from the catchment by surface runoff is small, compared to the amounts of carbon fixed and released by the forest biomass. The fate of the exported DOC depends largely on hydrologic flow paths, soil physical-chemical interactions, biological mineralization, dilution, and other processes specific to the aquatic media (Cronan and Aiken, 1985; St. Louis et al., 1994a; Curtis and Schindler, 1997; Hinton et al., 1997).

The hydrologic changes affecting runoff and DOC export depend on highly interactive factors, e.g., precipitation patterns, soil moisture, and increased discharge (Buringh, 1984; Chen et al., 1984; Cronan and Aiken, 1985; Moore, 1989; Nriagu, 1989; St. Louis et al., 1994a; Ash, 1995; Pettersson et al., 1995; Curtis and Schindler, 1997; Hinton et al., 1997; Schiff et al., 1997). For instance, increased precipitation causes an intensification of surface runoff and an increase in DOC export from the forest watershed. This effect is more pronounced at higher soil moisture contents (Hinton et al., 1997). High discharge episodes are usually responsible for the highest levels of DOC export and can result from a variety of events, such as the spring snowmelt, different types of storms (Moore, 1989; Curtis and Schindler, 1997; Hinton et al., 1997), and deforestation (see previous section). In the case of deforestation, the areal extent of the disturbance is important as well (Brown et al., 1973; Fuller et al., 1988).

Once incorporated into surface runoff and later into a lake or another receiving water body, DOC plays an important role in determining the availability, solubility, sorption, transport and fate of nutrients, trace metals, and organic compounds. In addition, DOC may limit biological productivity, through absorption of light, and the acid-base balance of natural waters, by contributing organic acids (Chen et al., 1984; Cronan and Aiken, 1985; Moore, 1989; Moore and Jackson, 1989; Miskimmin et al., 1992; Curtis and Schindler, 1997; Hinton et al., 1997; Schiff et al., 1997). DOC is also an important nutritional source to terrestrial invertebrates and notably to the aquatic fauna of the receiving water body (Verta et al., 1989; Curtis and Schindler, 1997).

The amount of DOC delivered to a lake from surface runoff depends on characteristics of the lake and its catchment, such as the watershed area, catchment area

and water residence time. For instance, the concentration of DOC in lake water tends to be proportional to the ratio of watershed area to lake surface area, but inversely related to the water residence time in the lake basin (Miskimmin et al., 1992; Curtis and Schindler, 1997; Schiff et al., 1997). The proportion of wetland areas in the forested catchment is another influential factor, as most wetlands are large reservoirs and net exporters of organic carbon through outflowing streams. In fact, strong positive correlations have been observed between catchment area covered by peatlands and DOC export (Cronan and Aiken, 1985; Moore, 1989; Curtis and Schindler, 1997; Schiff et al., 1997).

In summary, it is very difficult to quantitatively estimate or model the export of DOC from catchments (Schiff et al., 1997). Such calculations are mostly performed by means of regressions of stream discharge and stream DOC concentration. Nevertheless, the uncertainties involved in the results are significant, as stream discharge only partially explains the total variability in DOC concentrations. In fact, depending on the type of catchment, stream discharge may be a poor predictor of DOC. In upland catchments of humid climate zones, DOC concentrations in runoff can be inversely related, or even unrelated, to discharge, depending on the hydrologic, climatic, and biogeochemical characteristics of the catchment (Moore, 1989; Moore and Jackson, 1989; Hinton et al., 1997). For instance, results reported by Eckhardt and Moore (1990) for eight catchments in Southern Quebec show significant relationships between DOC and stream discharge in the presence of wetlands, but not in their absence.

Despite the problems and difficulties involved in its estimation, DOC export is a powerful tool for tracking the effects of deforestation on soil geochemistry, as DOC responds quickly to such disturbance (Fuller et al., 1988; Moore, 1989). Although conflicting results have been reported on the impacts of clear-cutting on DOC export from forested catchments (Hobbie and Likens, 1973; Meyer and Tate, 1983; Schlesinger, 1984; Moore, 1989; Henderson and McMartin, 1995), deforestation (both clear-cutting and forest fires) usually magnifies the loss of DOC from the watershed. This pattern is not restricted to DOC, but usually extends to nutrients and trace metals (Cerri et al., 1991; van Wyk et al., 1992) – see previous section.

3. Mercury and methylmercury in the environment

The role of mercury as a pollutant and the toxicological implications of its accumulation in fish and man were only realized after high mercury levels were reported in fish from some lakes and coastal areas of Scandinavia, in the vicinity of chlor-alkali and cellulose plants. The accidents of Minamata and Niigata (Japan) in the 1960's and other noteworthy cases of large-scale mercury poisoning (e.g., in Iraq (1971-72), Guatemala, and Pakistan) also revealed the consequences of mercury contamination (Irukayama, 1967; Rissanen, 1972; Hara et al., 1976; Preston, 1989; Langlois et al., 1995; Suchanek et al., 1995; Kaiser, 1996). Nowadays, mercury is recognized as a very dangerous chemical pollutant, methylmercury being its most toxic species (Preston, 1989; Langlois et al., 1995).

3.1. Sources

Mercury is a relatively ubiquitous natural constituent of the environment. It is found in almost every environmental compartment, including air, volcanic gases, fresh water, seawater, soils, mineral ores, lake and river sediments, and living organisms (Slemr et al., 1981; Glass et al., 1986; Jernelov and Ramel, 1994, 1995; Gaudet et al., 1995; US-EPA, 1997). Concentrations of mercury in many of these compartments appear to have increased over the last 500 years. In the atmosphere and the surface of the oceans, for example, mercury concentrations have tripled over the past century. This increase is commonly attributed to anthropogenic point sources of mercury (Lucotte et al., 1992; Nater and Grigal, 1992; Yess, 1993; Jernelov and Ramel, 1994, 1995; Gaudet et al., 1995; Klein and Jacobs, 1995; US-EPA, 1997), i.e., stationary locations or fixed facilities from which mercury is discharged or emitted as a result of human activity (US-EPA, 1997). Mercury is also emitted by natural sources, such as weathering and degassing of the Earth's crust (Jernelov and Ramel, 1994, 1995; Gaudet et al., 1995; US-EPA, 1997). Lindqvist et al. (1991) estimate natural sources to represent 40 percent of total mercury emissions.

Most anthropogenic sources emit mercury to the atmosphere. They include waste disposal and incineration, ore smelting, fuel combustion, chemical and metallurgical processes (especially in instruments, in catalysis, in the chlor-alkali industry, and in the

synthesis of pesticides and pharmaceuticals), agricultural use of pesticides and sewage sludge, and dental applications (Chaney, 1973; Hogstrom et al, 1979; Fellenberg, 1980; Brosset, 1983; Lindqvist and Rodhe, 1985; Nriagu and Pacyna, 1988; Hultberg et al., 1994; Lodenius and Tulisalo, 1984; Cossa, 1990; Panda et al., 1992; Chu and Porcella, 1995; Matthews et al., 1995; Hempel et al., 1995; Henderson and McMartin, 1995; Rubin and Yu, 1996; US-EPA, 1997).

Different estimation techniques combined indicate that anthropogenic releases account for 40 to 75 percent of the current atmospheric mercury concentrations (US-EPA). Being a trans-border pollutant emitted by numerous countries, mercury is regarded as an international problem. In tropical countries, mercury is often employed in the process of gold extraction by amalgamation, and a serious menace to the ecosystem. The total number of gold-miners in the world using mercury amalgamation is estimated at about four million: 650,000 in Brazil, 250,000 in Tanzania, 250,000 in Indonesia, and 150,000 in Vietnam, to name a few (Jernelov and Ramel, 1994). Official statistics in these nations, however, do not portray the real use of mercury. Furthermore, it is strongly suspected that a large proportion of the mercury utilized is smuggled into those countries (Jernelov and Ramel, 1994, 1995).

Prediction of the environmental impact of mercury in these areas is difficult, since little is known about the behavior of mercury in tropical ecosystems, where the higher degree of complexity and specialized food chains might lead to a situation that differs from that of boreal zones (Jernelov and Ramel, 1994, 1995; Roulet et al., 1998a,b). In Brazil, for instance, gold mining is centered in the Amazon, an area extremely rich in water bodies (Jernelov and Ramel, 1994, 1995; Roulet et al., 1998c). Likewise, in Tanzania, the rapidly evolving gold-mining activities take place along rivers and creeks that flow into Lake Tanganyika (Jernelov and Ramel, 1994, 1995).

The Canadian Environmental Protection Act (CEPA), which was proclaimed in 1988 and is the basis of the federal government environmental protection legislation, has identified mercury as a priority toxicant. The Canadian Council of Ministers of the Environment (CCME) has, therefore, formulated national environmental quality guidelines for mercury levels in water, sediments, and soil (Gaudet et al., 1995). In Canada, mercury was recognized as an environmental problem as a result of the dramatic

elevation of aquatic concentrations due to chlor-alkali plant effluents and to flooding of new hydroelectric reservoirs. Flooding of forest areas to create reservoirs appreciably increases organic matter decomposition, dissolved oxygen consumption, and the resulting mercury mobility, bioavailability and methylation rate. Mercury levels in aquatic organisms are thus increased (Gobeil and Cossa, 1984; Jackson, 1988, 1991; Johnston et al., 1991; Verdon et al., 1991; Louchouart et al., 1993; Dmytriw et al., 1995; Jernelov and Ramel, 1995; Morrison and Thérien, 1995; Mucci et al., 1995; Porvari and Verta, 1995; Plourde et al., 1997; Tremblay and Lucotte, 1997).

3.2. Mercury in the atmosphere: emission, dispersion and scavenging

Canadian anthropogenic emissions of mercury to the atmosphere have been estimated at approximately 31 tons annually. In Canada, the major source of mercury is base metal recovery, which accounts for 45.2% of the total emissions. Power generation and combustion of coal, natural gas, petroleum products, and wood constitute the second largest source, contributing 25.8% of the total mercury emissions in Canada (Gaudet et al., 1995).

In the United States, the annual emission of anthropogenic mercury to the atmosphere is estimated at 158 tons, approximately 87 percent from combustion point sources, 10 percent from industrial point sources, and 2 percent from area sources. Geothermal power generation accounts for roughly one percent. Other source categories (e.g., refineries, agricultural burning, paint use, primary mercury production, by-product coke, mercury compound synthesis, and internal combustion of diesel and gasoline) whose current emissions cannot be estimated due to insufficient data may contribute as much as 20 percent more mercury to the total estimates of the United States (US-EPA, 1997).

Elemental mercury represents 98 percent of the total mercury in the atmosphere and is formed by reduction of Hg(II) (Cossa, 1990; Lindqvist et al., 1991; Mason et al., 1995). In the Northern Hemisphere, gaseous elemental mercury is uniformly distributed in the atmosphere, as a consequence of its short intrahemispherical mixing time of approximately 3 months (Slemr and Langer, 1992). This uniformity is also consistent with the estimated 6 to 24 months (one year on average) residence time of elemental

mercury in the atmosphere (Pfeiffer et al., 1991; Slemr and Langer, 1992; US-EPA, 1997). In the Southern Hemisphere, mixing time is also short, but the average concentration of total elemental mercury is significantly lower, 1.33 ng/m^3 , in comparison to 1.96 ng/m^3 in the Northern Hemisphere (Slemr et al., 1981; Slemr and Langer, 1992).

In areas of humid climate, the residence time of elemental mercury in the dominantly anthropogenic is strongly reduced, and the annual rate of mercury deposition increases (Pfeiffer et al., 1991; US-EPA, 1997). This causes the total gaseous mercury concentrations in the atmosphere to decrease to 1.6 ng/m^3 between 32°S and 19°N and 1.2 ng/m^3 south of 32°S , as compared to approximately 2.2 ng/m^3 north of 19°N (Slemr and Langer, 1992). Geographical variation in the rate of atmospheric deposition of mercury can be as high as 20-fold, due to differences in terrain, climate and meteorology, and in the amount of mercury in the atmosphere (US-EPA, 1997). Seasonal variation in deposition rates occur not only for gaseous elemental mercury, but also for particulate mercury (Brosset, 1981, 1982; Slemr and Langer, 1992), whose concentrations in the atmosphere decrease exponentially with distance from the source (Lodenius and Tulisalo, 1984; Klein and Jacobs, 1995; US-EPA, 1997).

3.3. Atmospheric deposition as a source of mercury to watersheds

In Northern Quebec it has been demonstrated that mercury of dominantly anthropogenic origin has been deposited from the atmosphere since the 1940's (Lucotte et al., 1995). Such deposition may occur either directly onto the water surface or indirectly via drainage basin vegetation and soils (Lucotte et al., 1992; Hultberg et al., 1994; Watras et al., 1994; Hintelmann et al., 1995). Mass balance calculations for lakes and watersheds in Canada, Sweden and the state of Wisconsin point to atmospheric deposition as the principal source of mercury (Fitzgerald and Watras, 1989; Mierle, 1990; Lindqvist et al., 1991). In Wisconsin, the direct deposition of airborne mercury to precipitation-dominated lakes is sufficient to account for the annual sediment and fish accumulation (Fitzgerald and Watras, 1989; Wiener et al., 1990). In the Lake Superior region, as well, atmospheric deposition constitutes the major mercury source for some lakes (Glass et al., 1986).

Methylmercury would account for approximately 2 percent of the total mercury deposited onto a watershed (Langlois et al., 1995; Lucotte et al., 1995). The atmospheric deposition of methylmercury displays a seasonal pattern, with higher deposition rates in spring and winter (Hultberg et al., 1994). In general, the relative importance of methylmercury sources to drainage lakes varies widely. Whereas in the Experimental Lakes Area (ELA) of Northwestern Ontario and in Wisconsin seepage lakes the atmospheric source of methylmercury is insignificant (St. Louis et al., 1994a; Watras et al., 1994), in Swedish lakes it is considered sufficient to account for the high methylmercury levels in water and fish (Hultberg and Iverfeldt, 1992).

3.4. Mercury from the catchment: terrestrial inputs to lakes

Fish mercury levels are higher in drainage lakes than in seepage lakes (Verta et al., 1994). This reflects the greater importance of terrestrial inputs of mercury to lakes in comparison to atmospheric inputs. Terrestrial mercury inputs consist of the remobilization and transport through the watershed of mercury associated with the vegetation or soil, eventually reaching a lake (Lucotte et al., 1992; St. Louis et al., 1994a). Forest vegetation constitutes a link between the atmosphere, the soil and the terrestrial food chain (Martin and Coughtrey, 1981). The trees take up elemental mercury through their leaves and incorporate it in their tissues. With plant death and decay this mercury ends up in litterfall (Iverfeldt, 1991; Lucotte et al., 1995; US-EPA, 1997).

Numerous other factors, besides the rate of inland atmospheric deposition, affect the terrestrial input of mercury to lake water. Among these are: vegetation, climate, seasonality, the rate of catchment erosion, the ratio of watershed area to lake surface area, the proportion of wetlands in the catchment, the residence time of water in the soil, the thickness of the soil layer, and other soil characteristics (Johnston et al., 1991; Meili, 1991b; St. Louis et al., 1994a; Verta et al., 1994; US-EPA, 1997). Wetlands and peatlands, because of their high organic carbon contents, are important terrestrial sources of methylmercury in near-pristine boreal ecosystems. Their areal extent in a catchment is related to the export rates of methylated as well as inorganic mercury (Driscoll et al., 1994; St. Louis et al., 1994a; Bishop et al., 1995; Krabbenhoft et al., 1995; Rudd, 1995; Branfireun et al., 1996).

3.5. The fate of mercury in lakes

Within the lake, inorganic mercury may follow three main pathways: particle scavenging and transport towards the sediments; conversion to elemental mercury and evasion from the water to the atmosphere; methylation and subsequent bioaccumulation and/or demethylation. The relative importance of mercury sedimentation and gaseous evasion processes varies from lake to lake and can be associated with the residence time of mercury in the upper water column. In lakes where epilimnetic mercury residence times are short, rates of sedimentation would be high compared to mercury evasion rates, and vice-versa (Watras et al., 1994).

3.6. Mercury concentrations in the environment

In Canada, mercury concentrations usually range from 0.02 to 0.15 $\mu\text{g/g}$ in soils, with an average of 0.05 $\mu\text{g/g}$ (Friske and Coker, 1995; Grondin et al., 1995), and from 1 to 20 ng/l in fresh water (Gaudet et al., 1995). In lake sediments, they do not normally exceed 0.3 $\mu\text{g/g}$, except near anthropogenic point sources (Friske and Coker, 1995). For instance, in Flin Flon (Manitoba), at the site of a base metal mining and smelting complex, sediment mercury levels as elevated as 6.39 $\mu\text{g/g}$ have been reported (Gaudet et al., 1995). Higher concentrations in fresh water have been observed in Ontario and Quebec near areas of gold, copper or zinc mineralization, in British Columbia in the vicinity of cinnabar (mercuric sulfide) deposits, and in some streams of Ontario, Yukon, Northern Manitoba, and Labrador, mainly due to the presence of massive sulfide and black shale deposits, glaciation, and faulted tectonically-active terrains (Gaudet et al., 1995; Henderson and McMartin, 1995). High concentrations of dissolved sulfide stabilize mercury in solution through complexation, whereas low sulfide concentrations promote the precipitation of mercury as mercuric sulfide (HgS) (Watras et al., 1994; Paquette and Helz, 1995).

Several researchers, including the National Geochemical Reconnaissance Program of the Geological Survey of Canada, have reported a large variability in mercury concentrations in lake water and sediments. Much of the variability can be directly related to the chemical composition of the soil water, bedrock, regolith, and glacial deposits in the surrounding watershed. Bedrock composition dictates lake water

chemistry, affecting, most of all, the mercury concentrations in the sediments. This is explained by the preferential concentration of mercury in certain rock types through igneous, metamorphic and sedimentary processes (St. Louis et al., 1994a; Friske and Coker, 1995; Krabbenhoft et al., 1995). For example, a mercury concentration of 200 ng/g would be anomalously high for lake sediments on a marble basement, but would be considered normal for sediments overlying shale, a rock type known to be naturally enriched in mercury and other trace metals (Friske and Coker, 1995). Another factor strongly affecting the concentration of mercury in sediments is their organic matter contents (Lucotte et al., 1995).

The chemical form or speciation of mercury controls the fate of mercury and influences the site risk assessment and recommended remedial actions. Adsorption has been recognized as an important process in determining the fate of trace metal contaminants in soils (Yin et al., 1996). The soil most likely acts as a competitive sink for contaminants (Lindqvist et al., 1991; Krabbenhoft and Babiarz, 1992; Barnett et al., 1995; Chu and Porcella, 1995; Pettersson et al., 1995; Sheppard et al., 1995). pH affects both the surface charge characteristics of soil particles and the speciation of the metal in solution (Yin et al., 1996), governing the extent of adsorption.

Notwithstanding the importance of pH, the soil type and its organic matter content seem to override it in determining the extent of mercury sorption, as mercury is expected to form very stable complexes with organic matter. In forest soil profiles, high mercury concentrations are confined to the O-horizon, demonstrating a strong association between mercury and organic carbon (Dudas and Pawluk, 1976; Lodenius et al., 1987; Semu et al., 1987; Verta et al., 1989; Lucotte et al., 1992; Severson et al., 1992; Hultberg et al., 1994; Grondin et al., 1995; Henderson and McMartin, 1995; Matthews et al., 1995; Mucci et al., 1995; Roulet and Lucotte, 1995). Low humus contents are enough to sorb significant amounts of mercury, whereas soil mineral fractions contribute little to the sorption of inorganic mercury, especially under acidic conditions (Trost and Bique, 1970; Fang, 1978; Landa, 1978; Lodenius et al., 1987; Dmytriw et al., 1995; Roulet and Lucotte, 1995; Yin et al., 1996).

3.7. Methylmercury in the environment

Methylmercury in lake water does not normally exceed ten percent of the total mercury, except in lakes that undergo hypolimnic anoxia during the summer stratification, where it can account for as much as 20 percent (Gobeil and Cossa, 1984; Cossa, 1990; Driscoll et al., 1995; Langlois et al., 1995; Branfireun et al., 1996). In spite of the low water concentrations, the mobility and bioavailability of methylmercury are superior to those of inorganic mercury. Furthermore, methylmercury is the most readily accumulated and the most poorly eliminated form of mercury, because of its lipophilicity (Preston, 1989; Yess, 1993). Methylmercury accumulation rates by most aquatic organisms are influenced by the structure of the aquatic trophic chain and by chemical factors such as pH, hardness, calcium and DOC concentrations, as well as by methylmercury contents in the water (Stoepler and Matthes, 1978; Johnston et al., 1991; Bloom, 1992; Miskimmin et al., 1992; Watras et al., 1994; Matthews et al., 1995; Branfireun et al., 1996).

In fish, methylmercury is a persistent contaminant, with a two-year residence time (Preston, 1989; Yess, 1993), and accounts for 85 to 95 percent of the total mercury (Gobeil and Cossa, 1984; Cossa, 1990; Bloom, 1992). Through bioaccumulation, the concentrations of methylmercury are increased along the food chain (Jackson, 1984, 1988; 1993; Preston, 1989; Bloom and Effler, 1990; Panda et al., 1992; Gaudet et al., 1995; Jones et al., 1995; Matthews et al., 1995; Gagnon et al., 1996). Consumption of fish is the dominant pathway of exposure to methylmercury for wildlife and fish-consuming humans (US-EPA, 1997). In the human body, the half-life of methylmercury is 70 days, in contrast to 4 or 5 days for inorganic mercury. Elimination of methylmercury is slow and difficult, the predominant excretion route being faeces, after partial demethylation. The areas primarily affected by methylmercury are the nervous system and the liver. For inorganic mercury, the kidneys are simultaneously the most affected area and the primary elimination agent (Thibaud, 1990).

3.8. The methylation process

Methylmercury concentrations are the net result of the concurrent processes of methylation and demethylation, i.e., the production and degradation of methylmercury

from and to inorganic mercury, respectively (Jackson, 1986, 1989; Ramlal et al., 1986; Steffan et al., 1988; Zhang and Planas, 1993). So far no effective way of measuring the rates of methylation or demethylation individually has been devised (Compeau and Bartha, 1984; Steffan et al., 1988; Verta et al., 1994).

In natural waters and sediments, methylation is primarily microbial (Holm and Cox, 1974; Ramlal et al., 1986; Winfrey and Rudd, 1990; Oremland et al., 1991; Regnell and Tunlid, 1991; Jackson, 1993; Louchouart et al., 1993; Zhang and Planas, 1993; Verta et al., 1994; Watras et al., 1994; Gilmour and Bloom, 1995; Matilainen, 1995; Oremland et al., 1995), but chemical or abiotic methylation has also been reported (Berman and Bartha, 1986; Lee and Hultberg, 1990; Matilainen et al., 1991; Zhang and Planas, 1993). pH may influence both the production of methylmercury and its partitioning between the water and sediments (Johnston et al., 1991). At low pH and high dissolved organic matter concentrations, inorganic mercury can undergo very fast transformation into monomethylmercury (Xun et al., 1987; Pfeiffer et al., 1991; Miskimmin et al., 1992). Other factors affecting methylation rates include: temperature, concentration of total mercury, amount and type of available organic matter, redox potential (Eh), bioavailability of nutrients, concentrations of sulfide and sulfate, physiographic characteristics of the watershed, type and size of the microbial community (Holm and Cox, 1974; Compeau and Bartha, 1983; Gobeil and Cossa, 1984; Jackson, 1984, 1986, 1988, 1991, 1993; Berman and Bartha, 1986; Preston, 1989; Verta et al., 1989; Gilmour and Henry, 1991; Lucotte et al., 1992; Bodaly et al., 1993; Louchouart et al., 1993; Ramlal et al., 1993; Choi and Bartha, 1994; Dmytriw et al., 1995; Driscoll et al., 1995; Mucci et al., 1995; Gagnon et al., 1996).

Notwithstanding the factors mentioned above, it is now well established that the concentrations of mercury and methylmercury in runoff water are strongly correlated with organic matter, especially DOC (Jackson, 1988, 1991; Verta et al., 1989; Mierle and Ingram, 1991; Jernelov and Ramel, 1994; Driscoll et al., 1995; Hempel et al., 1995; Hintelmann et al., 1995; Pettersson et al., 1995). DOC export to lakes has already been demonstrated to be strongly impacted by forest fires and clear-cutting. There are several types of dissolved organic carbon, among which the material responsible for lake water color seems to be the most efficient mercury carrier. Lake water color is often a better

predictor than DOC, as it has been shown to better correlate to lake water and fish concentrations of mercury and methylmercury. According to Kolka et al. (1999), particulate organic carbon (POC) is the main transporting agent of total mercury in watersheds, in spite of the importance of DOC.

4. Statement of the problem

In regions with no anthropogenic point source of mercury, aquatic environments were traditionally believed to remain largely unaffected by Hg contamination. This idea, however, is no longer accepted. In several of these remote aquatic environments, with emphasis given to lakes in forested areas, fish tissue mercury levels are so high as to exceed the maximum limit of 0.5 mg/kg for human consumption recommended by the World Health Organization (WHO) (Meili, 1991a; Regnell and Tunlid, 1991; Bodaly et al., 1993; Louchouart et al., 1993; OMOE and OMNR, 1993; Verta et al., 1994; Driscoll et al., 1995; Langlois et al., 1995; St. Louis et al., 1994a; Branfireun et al., 1996).

The contamination of remote lakes with mercury has been associated with atmospheric deposition of mercury. Briefly, mercury is transported from point sources over long distances and is globally dispersed in the atmosphere. As indicated previously, mercury loading occurs through wet or dry deposition, either directly onto the lake surface or indirectly through catchment drainage (Bloom and Watras, 1989; Verta et al., 1989; Iverfeldt, 1991; Lucotte et al., 1992, 1995; Slemr and Langer, 1992; Swain et al., 1992; Louchouart et al., 1993; Hultberg et al., 1994; Hintelman et al., 1995; Krabbenhoft et al., 1995; Mucci et al., 1995; Emteborg et al., 1996; US-EPA, 1997). Surface runoff is believed to contribute most of the lake water mercury contents, especially in association with dissolved or particulate terrestrial organic matter (Evans, 1986; Mierle, 1990; Lee and Iverfeldt, 1991; Meili, 1991a; Mierle and Ingram, 1991; Swain et al., 1992).

Concentrations of mercury and methylmercury in lake waters are strongly correlated to their dissolved organic carbon concentrations. Given that DOC export to catchment lakes is modified by forest fires and clear-cutting, it would be reasonable to expect that these perturbations affect the concentrations of mercury and methylmercury in lakes as well. Additional factors probably affect the extent to which forest fires and clear-cutting influence the contamination of lacustrine environments with mercury and

methylmercury. These factors include the hydrology and morphometry of the lake and catchment area, water chemistry (pH, redox potential, nutrients, ionic concentrations, dissolved oxygen contents), and physical variables, such as temperature and light extinction coefficient.

5. Objectives

5.1. Determine the effects of forest fires and logging activities on the concentrations of methylmercury in the water column of the lakes, both in the particulate and dissolved fractions, and on the concentrations of total mercury in surficial bottom sediments.

5.2. Determine the differential effects of forest fires and clear-cutting using the concentrations of the non-impacted watershed lakes as background reference levels.

5.3. Correlate methylmercury and total mercury concentrations with morphometric parameters of the lakes and/or their catchments within each treatment group.

6. Working hypothesis

Forest fires and clear-cutting affect the export of DOC and mercury from forested watersheds to lakes, and the concentrations of methylmercury in the water column of these lakes. This is mediated by a commonly observed correlation between DOC and methylmercury concentrations in lakes and the type and extent of watershed perturbation.

II-STUDY AREA

1. Physical description of the area

The study site consists of 38 headwater lakes located between 47°52'N and 48°59'N latitude, and between 73°24'W and 76°43'W longitude (Figure II.1). The lakes cover an area of 40,000 km² on the Canadian Shield and are centered on the Gouin Reservoir, in the central region of Haute Mauricie, in the Province of Quebec.

The region is underlain by granitic and metamorphic rocks (gneiss, mangerite, and migmatite) covered by glacial tills. The tills derive mainly from local bedrock and are non-calcareous, coarse-grained and poor in clay-sized particles. The average thickness of the tills is about 2 meters, but they may be absent on some hilltops, or exceed 10 meters in valleys. Soils are mostly ferric podzols (Clayton et al., 1978; De Kimpe et al., 1980; Scott, 1980; Vincent, 1989; Environment Canada, 1992).

The lakes overlap the transition zone of boreal mixed and coniferous forests. Catchments are forested primarily with yellow birch (*Betula alleghaniensis*), sugar maple (*Acer saccharum*), balsam fir (*Abies balsamea*), trembling aspen (*Populus tremuloides*), and black spruce (*Picea mariana*). Because of logging, fire and spruce budworm (*Zeiraphera canadensis*) outbreaks, the mean age of the forest is 50 to 60 years, but occasionally exceeds 100 years (Payette et al., 1990). Although there are wetlands in the area (e.g., bogs, marshes, and beaver ponds), they account for less than 5 percent of the drainage area of the studied lakes. The climate is continental, with a mean annual temperature of 0°C, and mean annual precipitation ranging from 800 to 1000 mm. Snow accounts for 35 percent of this precipitation (Atlas Climatologique du Québec, 1978).

2. Lake and catchment morphometry

The lakes have been selected according to the type and degree of watershed disturbance, in order to produce three groups with similar distributions of morphometric properties (Tables II.1 to II.4).

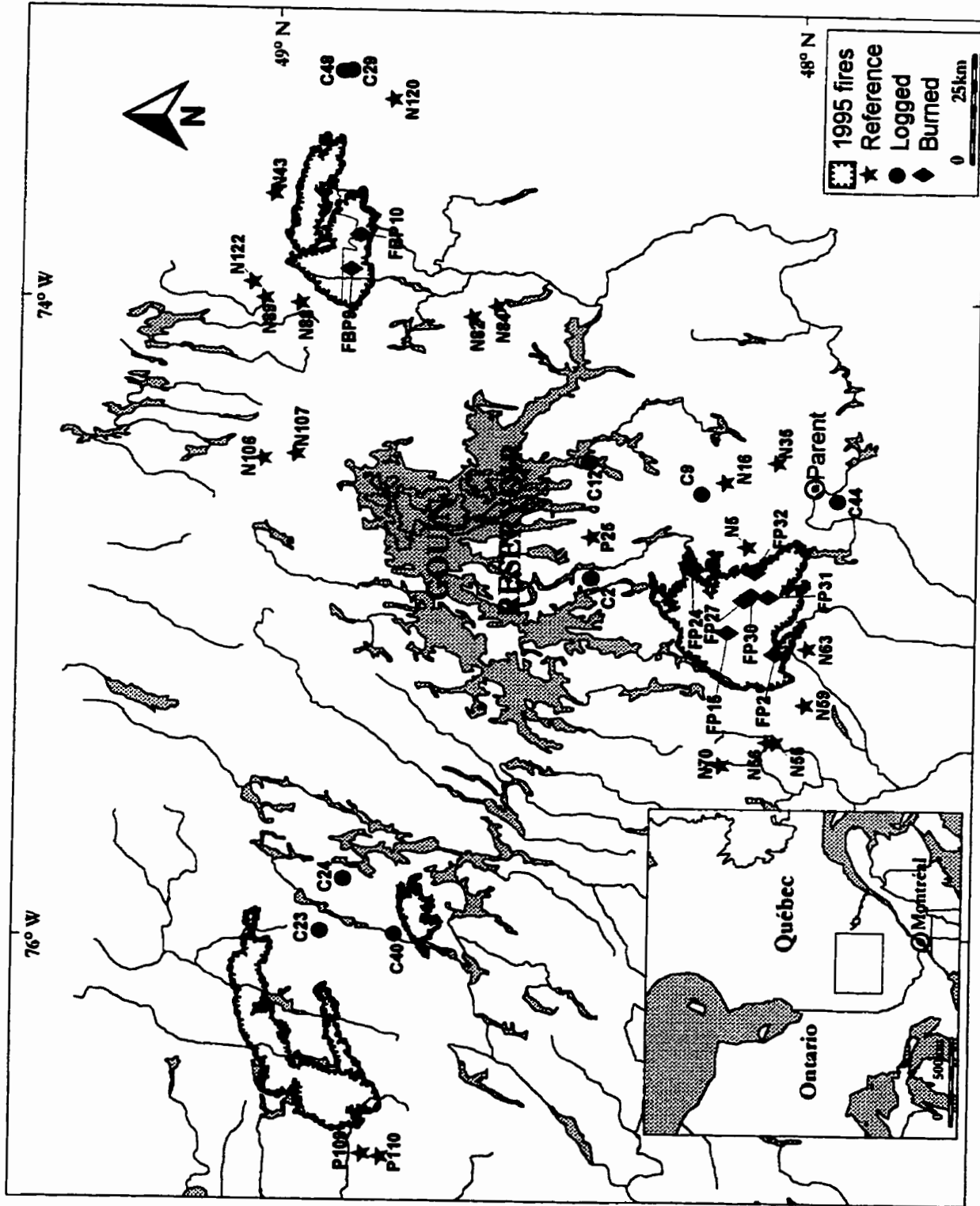

Figure II.1.1. Map of the study area

2.1. Definition of morphometric terms

LA: Lake area (km^2): Surface area of the lake under consideration.

LP: Lake perimeter (km).

LS: Lake slope (percent), obtained from bathimetric maps.

LV: Lake volume (10^{-3} km^3). The volume of the basin is the integral of the areas of each stratum at successive depths from the surface to the point of maximum depth (Wetzel, 1975).

Zmax: Lake maximum depth (m).

Zmean: Lake mean depth (m).

SD: Shore density or shoreline development: Ratio of the lake perimeter (LP) to the circumference of a circle whose area is equal to the lake area (LA):

$$SD = LP / 2 \sqrt{\pi * LA} \quad (\text{equation II.1}).$$

Shoreline development (SD) reflects the potential for the development of littoral communities in proportion to the lake volume. Circular lakes approach the minimum SD value of unity (Wetzel, 1975).

Alt.: Lake altitude (m).

T: Lake water residence time (years).

CA: Catchment area (km^2): Area covered by lakes and surface runoff .

WA: Watershed area (km^2): Area covered by the surface runoff; it can be expressed as the difference between the catchment area and the sum of lake areas:

$$WA = CA - \sum (LA) \quad (\text{equation II.2}).$$

WA/LA: Ratio of the watershed area to the lake area.

CP: Catchment perimeter (km).

DD: Drainage density (km/km^2).

CS: Catchment slope (percent), obtained from bathimetric maps.

LZS: Littoral zone slope (percent), obtained from bathimetric maps. The littoral zone was delimited between 0 and 2 meters.

Q: Water flow ($10^{-3} \text{ km}^3/\text{year}$): 0.513 times the catchment area given in square meters.

CSL: Catchment stream length (km).

3. Experimental design

Initially the experimental design consisted of:

- 9 lakes that had 7.5% to 96.4% of their catchment areas clear-cut in 1995 (Table II.5);
- 9 lakes that had 50% to 100 % of their catchment areas affected by maximum intensity fires in 1995 (Table II.6);
- 20 reference lakes (null treatment), whose catchment areas had remained undisturbed for at least 70 years. Reference lakes were selected using provincial vegetation maps.

During the winter of 1997-98, four of the former reference lakes (N106, N107, P25, P110) had their watersheds logged. In addition, the watershed area of lake C2, which had already been cut in 1995, underwent additional logging. The percent of logging as of May 1998 is given in Table II.7.

III - MATERIALS AND METHODS

1. Water column sampling for methylmercury analysis

Water column samples were collected in September 1997 and in May 1998. The reason for choosing these two periods was to represent two contrasting seasons: early spring (May), after the snowmelt, and late summer (September). In September, sampling was performed at one or two depths, depending on lake water column stratification. When the water column was homogeneous, as determined from the temperature or oxygen profiles, only one sample was taken at mid-depth. When there was strong stratification, one sample was collected at 1 meter below the surface (in the epilimnion), and another in the minimum oxygen zone or hypolimnium. In May 1998, only one water sample was collected from each lake, at mid-depth, as the water column was assumed to be well mixed after the spring thaw and before the onset of summer thermal stratification. All May 1998 samples and some of the September 1997 water samples were filtered on site. Filtered and unfiltered water samples were stored in 250-ml Teflon PFE/FEP bottles provided with 24-mm Tefzel ETFE screw closure lids.

Sampling was performed by personnel from the University of Montreal. The procedure was carried out in the absence of dust and with polyethylene gloves to avoid contamination. All samples were collected from the pontoon of a hydroplane, using a Masterflex Easy-Load hand-operated peristaltic pump model 7529-80. Connected to the pump was a silicone-peroxide tube, previously washed with 10% HCl (about 2N) and tap water. This tube was lowered to the desired depth in the lake water column, fastened to a meter-scaled polyethylene cable. At each sampling site, the silicone-peroxide tube was flushed with ambient water at a flow rate of 1-2 liters per minute. The sampling bottles (and their lids) were equally rinsed with ambient water and then filled, allowing for headspace gas. Tightly closed, the bottles were inserted in a clean, identified Ziploc bag.

Filtration was performed in the field, using a 47-mm Teflon PFA in-line filter-holder and pre-weighed EPM 2000[®] filters with 0.30 μm pore size. The filter-holder was rinsed with ambient water at each site, both before and after use. Filtration was carried out until the filter was clogged with the suspended particulate matter (SPM), i.e., the material retained. The volume of filtered water ranged from 750 ml to 10.1 liters and was measured by means of a 1000-ml graduated cylinder, before being transferred to the

rinsed storage bottle.

2. Filter processing prior to the methylmercury analysis on the SPM

The filters, on which the SPM was isolated, were removed from the filter-holder using tweezers. They were stored in sterile Petri dishes (50x9 mm, Gelman Sciences) and immediately frozen. In the laboratory, they were freeze-dried for approximately 48 hours and re-weighed. The difference in weight, i.e., the dry weight of SPM, was divided by the volume of filtered water, in order to obtain the concentration of SPM in the water column at each sampling depth. The purpose of freeze-drying was determining the SPM dry weight, at the same time as stopping the bacterial methylation and demethylation processes (Emteborg et al., 1996). Heat drying, as an alternative for water removal, is not appropriate for preserving the methylmercury concentrations.

Total carbon (ΣC) and total nitrogen (ΣN) contents were measured on subsamples of the filters, using a Carlo-ErbaTM Elemental Analyzer, with a detection limit of approximately 0.1% C and <0.05% N by weight (Bono, 1997), and a reproducibility around 5%. These measurements were carried out at GEOTOP/UQAM.

Methylmercury was extracted from the binding sites of the suspended particulate matter (Horvat et al., 1990; Horvat et al., 1993a) with 5 ml of an alkaline solution (i.e., 25% KOH-methanol) and 24-hour wrist-action shaker agitation. The alkaline extraction solution was prepared by dissolving 25 g of KOH (American Chemicals) in 20 ml of acetone-free methanol (American Chemicals) and completing the volume to 100 ml with tap water. Over the past decade, recoveries close to 100% have been reported from intercomparison exercises and from the analysis of certified reference material directly after alkaline digestion. This indicates that this extraction procedure efficiently releases mercury compounds (Horvat et al., 1993a; Liang et al., 1994, 1996). Methylmercury analysis was carried out within two days of the extraction, in order to prevent loss of methylmercury by decomposition and re-adsorption onto the particulate matter (Haraldsson et al., 1989; Horvat et al., 1993b).

3. Distillation of the water samples

Due to low ambient concentrations, methylmercury usually needs to be

concentrated from the original sample by an extraction step prior to analysis. This extraction procedure also isolates the methylmercury from interfering matrix components such as those of dissolved sulfide and organic matter (Haraldsson et al., 1989; Lee and Mowrer, 1989; Siriraks et al., 1990; Horvat et al., 1993a; Bloom and Vondergeest, 1995; Liang et al., 1996). Methylmercury was extracted from the water samples prior to the analysis by means of distillation, so eliminating the organic matter, which could interfere with the ethylation reaction. Without the extraction, the concentrations of methylmercury could be underestimated because of its strong affinity for dissolved organic carbon (Horvat et al., 1993a,b; Bloom et al., 1995). Water sample distillation was carried out according to the method of Horvat et al. (1993a,b). This method is very efficient, consistently giving high recoveries (80-95%), but requires careful attention to the purge gas flow pressure/rate and the completeness of the distillation (Horvat et al., 1993b).

Methylmercury distills approximately azeotropically with water, resulting in a solution very easily and reproducibly analyzed by the ethylation/ gas-chromatography/ CVAF spectrometric method (Bloom, 1989; Bloom and Vondergeest, 1995). Distillation is also effective in separating methylmercury from inorganic mercury and dimethylmercury. Even if other mercury compounds are distilled, their concentrations in the distillate are always much lower than before distillation, by no means impairing the accuracy of the methylmercury determination (Horvat et al., 1993a,b).

The distillation system (Figure III.1) consisted of twelve 60-ml midget impingers and twelve 120-ml receiving containers, all in Teflon PFA. Each impinger was linked to a receiving container by means of Teflon FEP tubing (3/16x1/4x1/32"), and both containers were equipped with 2-port transfer caps (Savillex). The twelve impingers were inserted in an aluminum solid block stand, which was heated to 110°C by means of a Thermix 210T stirring hot-plate (Fisher Scientific). At 110°C, the water and methylmercury in the sample were vaporized, leaving the organic matter and other solutes behind, and carried along the Teflon tubing into the receiving containers, where they condense. Higher temperatures might cause decomposition of the methylmercury and were, for this reason, avoided. The temperature was constantly monitored with a mercury thermometer. Mercury-free argon (Matheson) served as the carrier gas and was

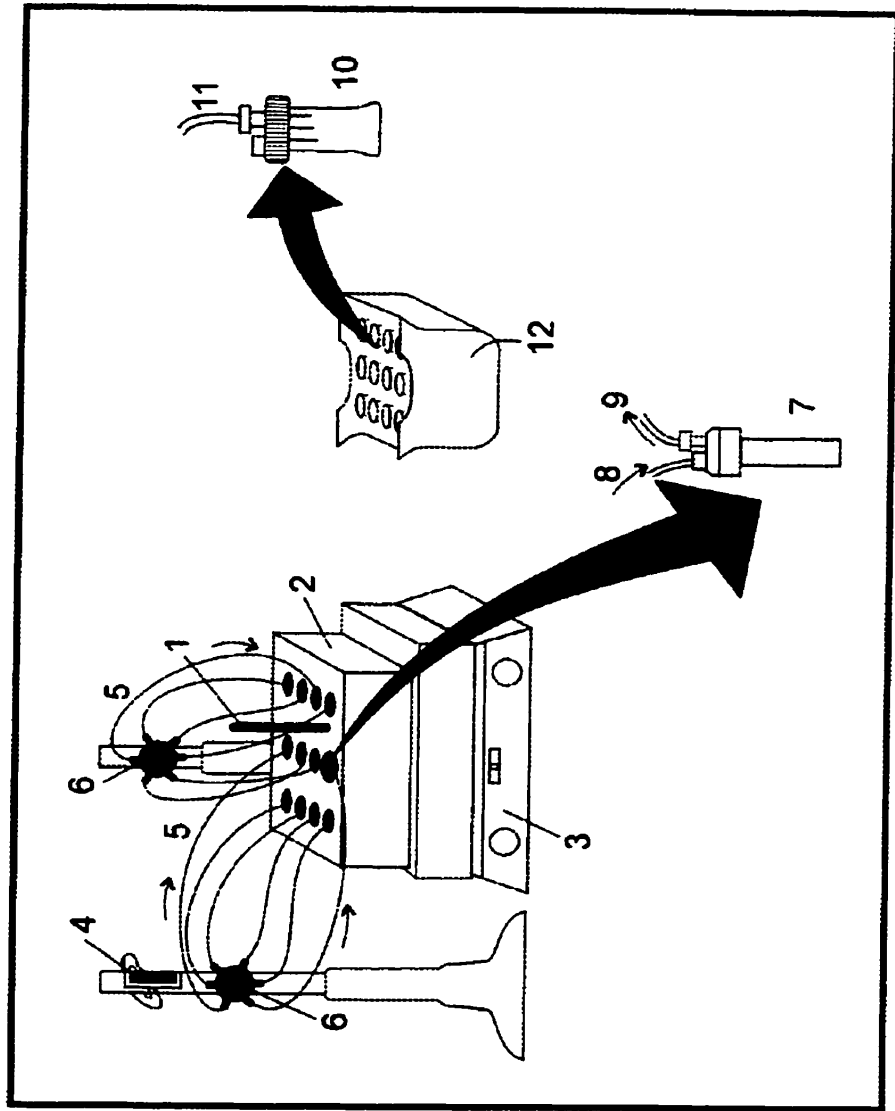

Figure III.1. Distillation system.

1. Thermometer.
 2. Solid block stand.
 3. Stirring hot-plate.
 4. Argon gas flowmeter.
 5. Teflon tubing (for argon).
 6. Argon gas distribution splitter.
 7. Impinger.
 8. Argon inflow (teflon tubing).
 9. Outflow to receiving container (teflon tubing).
 10. Receiving container.
 11. Input from impinger (teflon tubing).
 12. Ice-cooled water bath.
- Arrows indicate the direction of argon flow.

kept flowing from the impingers to the receiving containers with a pressure of approximately 40 mm. At lower pressures, the efficiency of the distillation decreased significantly, because the fluid was not adequately transported along the system. Conversely, at higher pressures, the sample would flush through the Teflon tubing in the liquid instead of gaseous state, which was also undesirable (Horvat et al., 1993a).

Three samples were distilled simultaneously, each divided into four 55-ml aliquots. In order to improve methylmercury recovery, 44 mg of KCl and 1 ml of 8M H₂SO₄ were added to each aliquot (Horvat et al., 1993b; Bloom and Vondergeest, 1995; Emteborg et al., 1996). This amount of KCl is added in order to obtain a final chloride concentration of 0.08% (Horvat et al., 1993b). The distillation was allowed to proceed until 85-90% of the initial volume of the aliquot was transferred to the receiving containers. Beyond that point, methylmercury might decompose, and undesired substances, such as inorganic mercury, can usually be transferred to the receiving containers. This may lower the pH of the distillate, affecting the ethylation step of the analysis (Horvat et al., 1993b).

Once the distillation of each set of three samples was completed, the distillation apparatus was cleaned in order to avoid the contamination of subsequent samples. Cleaning was carried out by flushing the system first with 20 ml of a 4% HCl solution (10 ml of HCl in 240 ml of tap water) and then with tap water at 110°C. Argon was again the carrier gas, at a pressure of 40 mm. The time required for completing the distillation of three samples, including the cleaning procedure, ranged from 9 to 14 hours. The mean efficiency of the distillation, measured in terms of methylmercury recovery from analyzed standards, was 89%.

The receiving containers were kept immersed in an ice-cooled water bath, and the distillates were stored in Teflon FEP and/or PFA bottles, under refrigeration and in the dark. Under such conditions, methylmercury is stable for at least two weeks, as thermal and photodecomposition are minimized (Horvat et al., 1990, 1993b). In order to avoid these and other problems with sample preservation, such as the risk of contamination, loss of mercury by volatilization and absorption to the walls of the container (Stoepler and Matthes, 1978; Gill and Fitzgerald, 1987; Haraldsson et al., 1989; Lansens et al., 1990), samples were distilled and analyzed as soon as possible. Another potential

problem is the loss of methylmercury due to the presence of humic substances, especially important in the case of unfiltered samples. Lee and Mowrer (1989) found that approximately 15% of the methylmercury in a sample containing humic matter were lost after 2-month storage.

4. Methylmercury analyses: water and SPM

All methylmercury analyses were performed according to the method of Bloom (1989), using aqueous-phase ethylation, room temperature trapping and pre-collection, gas-chromatographic separation and cold vapor atomic fluorescence (CVAF) spectrometric detection. This method is remarkably more sensitive and has several other advantages compared to other techniques (Bloom, 1989; Liang et al., 1994). The primary advantage is the easy isolation of methylmercury from the sample matrix by simply purging its volatile ethylation product, methylethylmercury (Liang et al., 1996). A Model-2 CVAF spectrometer (Brooks Rand), whose design and installation is detailed by Bloom and Fitzgerald (1988), was used. The output signal of the spectrometer was transferred to a signal integrator: a Hewlett Packard Integrator model 3390A, for the SPM analyses, and a Toshiba 133 MHz Pentium laptop operating the Low Cost Chromatography (LCC) Data Acquisition System software, Windows version 1.4 (Analytical Instrument Systems), for the water sample analyses.

Aqueous-phase ethylation was carried out in a 250-ml flat bottom flask with a 2-port transfer bubbling-tube-cap (Pyrex). The cap was connected on one side to a gold-coated sand-trap column, and on the opposite side to a quartz-glass trapping column containing about 100 mg of Tenax TA (20/35 mesh, Alltech). The Tenax TA was held in place by silane-treated glass wool (Supelco Canada). The construction of the trapping column is described in Liang et al. (1994). Mercury-free argon at a pressure of 30 mm was intermittently channeled through the system. All connections were made of Teflon (Figure III.2).

The ethylation reagents comprised tap water, sodium-acetate buffer, sample

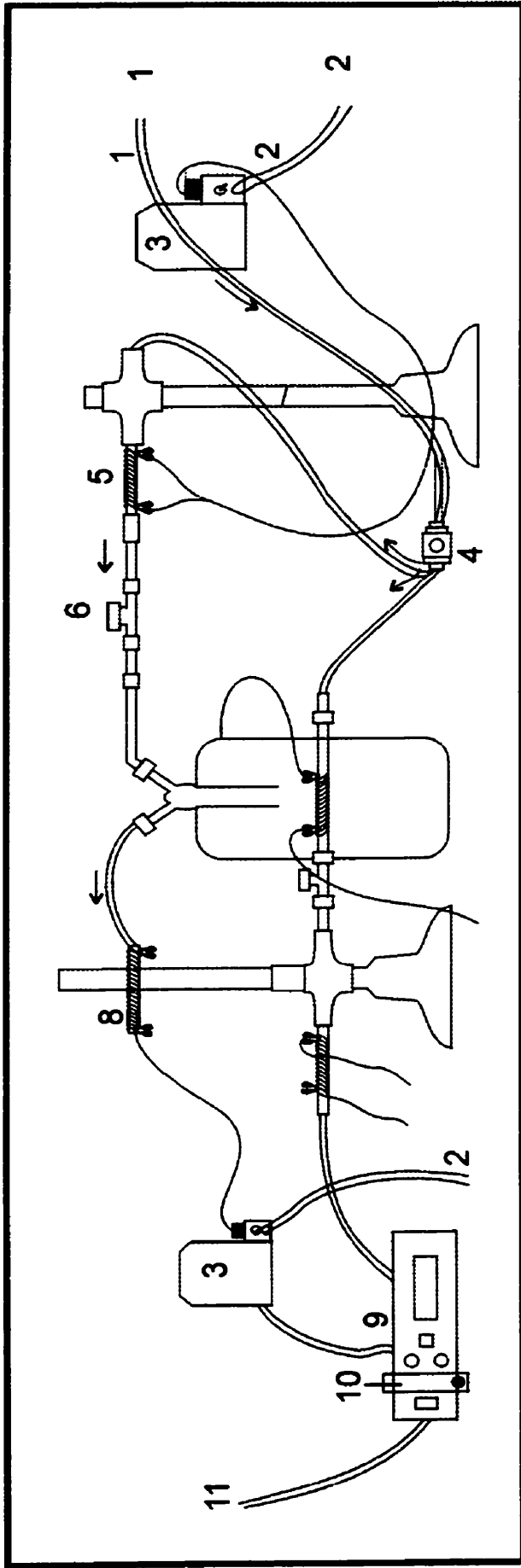

Figure III.2. CVAFS analytical system.

1. To argon flow.
 2. To electrical outlet.
 3. Rheostat.
 4. Argon gas valve.
 5. Tenax column.
 6. Injection.
 7. Chromatographic column.
 8. Quartz column.
 9. Fluorimeter.
 10. Argon gas flowmeter.
 11. To integrator.
- Arrows indicate the direction of argon gas flow.

extract/distillate, and 1% sodium-tetraethyl-borate (Strem Chemical), added to the flask in this sequence. Tap water was used instead of Nanopure[®] because in our facilities the former has been shown to contain less mercury. The sodium-acetate buffer was prepared by dissolving 27.17 g of sodium acetate and 11.83 ml of glacial acetic acid into some tap water and completing the volume to 100 ml with tap water. The amount of buffer should suffice to keep the pH of the ethylation solution within the optimal range of 4.5 to 5.0 (Horvat et al., 1993a; Liang et al., 1994). At lower pH, interferences may result in low methylmercury recovery (Horvat et al., 1993a,b). Other parameters affecting the ethylation include reaction temperature and time, purge gas flow pressure/rate, purge time, and concentration of the ethylation agent (sodium-tetraethyl-borate). The optimal reaction temperature range is 20° to 30°C. Lower temperatures require longer reaction times (Liang et al., 1994).

Analytical details, such as the precise amounts of reagents and the reaction and purge times, differed between the SPM and the water sample analyses. For the analysis of methylmercury in the distilled water samples, these amounts were 100 ml of tap water, 200 µl of sodium-acetate buffer, 40 ml of sample distillate, and 100 µl of a 1% sodium-tetraethylborate solution. The reaction was allowed to proceed for 12 minutes, and the purging with argon for another 12 minutes. For the analysis of methylmercury in the SPM, the ethylation reaction was performed with 100 ml of tap water, 700 µl of sodium-acetate buffer, 250 µl of the extract, and 100 µl of sodium-tetraethylborate. The reaction was allowed to proceed for 10 minutes before purging with argon for 15 minutes. Stirring should be continuous in both cases.

Ethylation products consist of ethylmethylmercury and diethylmercury, which derive, respectively, from reactive methylmercury and inorganic mercury contained in the sample. The ethylmethylmercury and the diethylmercury both adsorb onto the Tenax contained in the quartz-glass column. This trapping column is then purged dry with argon gas at a pressure of 30 mm during ten minutes. This eliminates traces of water, which may strongly interfere with the subsequent processes of chromatographic elution and CVA-F spectrometric detection (Horvat et al., 1993a). Once dry, the Tenax column is transferred to the analytical system and heated to 200°C for approximately five minutes. At this temperature, the ethylated mercury species desorb from the Tenax. Higher

temperatures may cause thermal decomposition of the organo-mercury species. Swept into the chromatographic column by argon gas, ethylmercury and diethylmercury are isothermally (85°C) separated according to their boiling points (Liang et al., 1994). These two species are then individually carried into a quartz column at 800°C, where they decompose, producing elemental mercury (Hg^0). The resulting elemental mercury is detected by the fluorimeter as two separate signals. One signal corresponds to diethylmercury derived from elemental mercury, while the other corresponds to ethylmercury produced from monomethylmercury. Each signal is integrated into a peak, whose area is proportional to the mass of mercury contained in the respective ethylated species. A known amount of inorganic mercury vapor is injected into the system in order to generate a peak used for internal calibration. By knowing the peak areas and the mass of the injected inorganic mercury, the masses of mercury contained in the methylethylmercury and the diethylmercury peaks can be calculated. Assuming all methylethylmercury present is derived from the methylmercury originally contained in the sample (i.e., there is no contamination or loss of methylmercury along the procedure), the calculated mass of mercury in the form of methylethylmercury is the same as in the original sample aliquot used.

Each sample was analyzed at least three times, or until a reproducibility of better than 15 percent was obtained. The percent error (Table IV.7) was calculated as the averaged percent deviation of each replicate from the mean of all replicates. Blank tests were run at the beginning of each analysis session. Methylmercury chloride standards of known mercury concentrations were periodically analyzed following the same procedure used for the distilled samples in order to ensure the proper performance of the system. The ethylation reagents, in this case, comprised 1 ml of methylmercury chloride standard working solution (1 ng/ml of mercury), 100 ml of tap water, 200 μl of the sodium-acetate buffer solution and 100 μl of the 1% sodium-tetraethyl-borate solution added in this order. The standard working solution was prepared daily through a three-step dilution process starting with a methylmercury chloride standard stock solution of 1 mg/ml concentration. In each of the three steps, the solution was diluted 100 times and acidified to 0.5% HCl (American Chemicals), reaching a final concentration of 1 ng/ml of mercury as methylmercury chloride. Both the stock and working standard solutions were kept in

the dark to prevent photodecomposition of the methylmercury chloride (Horvat et al., 1990).

The detection limit (minimum detectable concentration) of mercury for the water and the SPM analyses was, respectively, 2.8 ng/l and 4.3 ng/l (1.2 ng Hg/g SPM). The detection limit is determined by variations in the blank and is calculated, as recommended by the IUPAC method, as the mean methylmercury concentration of the blank (0.42 ng/l and 0.23 ng/l of mercury as methylmercury, respectively, for water and SPM) plus three times its standard deviation (Winefordner and Long, 1983; Haraldsson et al., 1989; Horvat et al., 1993b).

5. Total mercury in the bottom sediments

Surficial bottom sediments were sampled from all lakes in July 1997. The samples were collected with a box corer, which was slowly lowered by hand to the bottom of the lake while depth was recorded. The surface floc was removed from each sediment core with a 60-cc syringe and homogenized by shaking. The homogenate was transferred to a pair of pre-weighed scintillation vials. These vials were tightly closed, so as to prevent water loss by evaporation and were re-weighed.

One vial was frozen, freeze-dried for 48 hours, and weighed once again for water content determination (99.88 ± 0.05). The remaining solids in this vial were analyzed for total carbon (ΣC) and total nitrogen (ΣN) contents. These two determinations were carried out at GEOTOP/UQAM, using a Carlo-ErbaTM Elemental Analyzer, with a detection limit of approximately 0.1% C and <0.05% N by weight (Bono, 1997), and a reproducibility of 5%. The content of the other vial was divided into 5-10 g subsamples, which were acid-digested in Teflon reactors (Savillex) with a 10:1 HNO₃-HCl mixture and then analyzed for total mercury at Centre Saint-Laurent (Dr. B. Quémerais and M. Benoit Fortin).

The total mercury analysis was performed in two stages: pre-concentration and detection. The preconcentration step consisted of dissociating mercury from its organic complexes by oxidation with BrCl (Quémerais and Cossa, 1995). Bromine monochloride (BrCl), apart from being contamination-free, is an excellent oxidant and preservative for total mercury in freshwater material, working faster and more efficiently than other

oxidants (Szakácss et al., 1980; Bloom and Crecelius, 1983). Resulting mono- and divalent mercury forms were then reduced into elemental mercury with SnCl_2 . Hydroxylamine was finally added in order to neutralize the BrCl , since trace amounts of Br interfere with mercury trapping (Quémerais and Cossa, 1995). Detection was achieved with CVAF spectrometry, as described for the water sample distillates and SPM extracts.

6. Water chemistry

The water chemistry of the lakes was characterized in detail by other project participants (Carignan et al., 1999; Planas, 1999). Briefly, the lakes were sampled in June, July and September 1996, June, July and September 1997, and May, July and September 1998. Duplicate water samples for chemical analyses were taken with a flexible PVC tube from the bottom of the euphotic zone (1% of the incident light).

Dissolved organic carbon (DOC) and nitrate:

Water collected for dissolved organic carbon (DOC) and nitrate (NO_3^-) analyses was filtered within 6 hours of sampling using 0.45- μm pore size pre-washed Gelman Supor membranes. The DOC concentrations were measured with a high temperature Pt-catalyzed Shimadzu TOC-5000 analyzer.

Nitrate was determined within 48 hours of sampling by an automated colorimetric method following reduction on a Cd column (Lachat method No. 10-107-04-1-B). Total phosphorus levels were determined after autoclaving 50-ml sample aliquots with 0.5 g of potassium persulfate for 45 minutes at 120°C.

Sulphate:

Sulphate was analyzed by ion chromatography (Dionex DX-500). Alkalinity, obtained from Gran titration (Stumm and Morgan, 1996), and pH were measured on air-equilibrated water samples within 48 hours of collection with a double junction electrode (Carignan et al., 1999).

Chlorophyll-a:

Chlorophyll-a determinations were performed at GEOTOP/UQAM (Dr. D.

Planas). For each sample, 500-ml aliquots were filtered in subdued light on Whatman GFC filters. These filters were wrapped in aluminum foil and, after freezing to -30°C , were extracted with hot ethanol (Sartory and Grobelaar, 1984; Nusch, 1980). Pigment absorbance was read at 665 and 750 nm both before and after acidification (Planas, 1999).

7. Statistical analyses

The three treatment groups of lakes were carefully chosen not to differ significantly in terms of lake and catchment morphometry. Therefore, all observed differences in group mean concentrations of mercury in the sediments, methylmercury in the dissolved and particulate (SPM) forms, and water chemistry in general can be attributed to the effects of forest fires (lakes of the burnt group) and clear-cutting (lakes of the logged group) in relation to the reference, undisturbed state (control group). However, minor variations in morphometry and inferred hydrology exist within each group, i.e., there are physiographic differences among lakes (and their respective watersheds) within a same treatment group (refer to Tables II.1 through II.4). These differences can be held responsible for the within-group variation of the chemical properties of the lake waters. This variability can be expressed either as a group variance or standard deviation, or as the standard deviation of the mean (standard error), which was the form used in this study. Consequently, the effects of clear-cutting and forest fires upon the water quality of the lakes can be analyzed at two levels: among-group differences, and within-group differences.

7.1. Among-group differences

Among-group differences were statistically tested by one-way analysis of variance (ANOVA), which consists of calculating group means and their respective probability of occurrence in a normal population. This probability of occurrence, known as the p-level, should be compared against the arbitrarily chosen α -level. To the confidence level of 95% used in this study, corresponds an α -level of 5%, or 0.05. In this case, if the probability of occurrence of each group mean falls within the confidence level ($p > \alpha$), all groups are said to come from the same population, i.e., their means are not

significantly different in statistical terms. However, if one of the group means shows a very small probability of occurrence (i.e., $p < \alpha$), that group is said to be significantly different from the other two. In order to apply one-way ANOVA to group means, group variances (variance of the data within each group) must be homogeneous, i.e., they must not differ significantly, in statistical terms, when tested with one-way ANOVA. If the variances differ significantly at the chosen confidence level (i.e., $p < \alpha$), the data in all groups must be numerically transformed. Different transformations (e.g., logarithmic, reciprocal, square root) should be tested, and the one that best homogenizes the variance should be used. Logarithmic transformation was applied to the DOC concentrations in the water column in September 1997 in order to make their variances less heterogeneous. This was necessary because variation within each group was proportional to the respective group mean.

7.2. Within-group differences

A forward stepwise regression model was developed relating each lake water quality variable analyzed (i.e., methylmercury in the SPM, dissolved methylmercury, total mercury in the surficial bottom sediments), to morphometric parameters of the lakes and their catchments (see II.2.1 for definitions). These parameters were considered as independent variables (i.e., collinearity was not accounted for), although several of them are actually related, such as lake and catchment dimensions (area, volume, perimeter, depth) and measurements concerning hydrology (e.g., residence time, flow, drainage density, slopes). A forward stepwise regression model was also developed relating the dissolved methylmercury concentrations to chemical parameters (e.g., DOC, total nitrogen, total phosphorus, and pH) in the water column. The calculated Pearson's determination coefficients are presented in Tables IV.12, IV.13, IV.14, and IV.15. The significance of each morphometric parameter towards the respective regression model was determined by comparing the calculated p-significance level against the chosen α -level of 0.05 (95% confidence interval). A given parameter was considered significant when $p < \alpha$. When p was between 0.05 and 0.07, the parameter was reported as close to significant with respect to the regression model.

IV – RESULTS

A. Among-group differences

1. September 1997

1.1. Suspended particulate matter (SPM)

The concentrations of suspended particulate matter (SPM) and its carbon-to-nitrogen (C/N) molar ratios and associated MeHg concentrations are given in Tables IV.1, IV.2 and IV.3, respectively for the logged, the burnt, and the reference groups. The depth in the lake water column at which each sample was collected is also given.

Averaging the results of all lakes in each group, we obtain the following values:

- Mean SPM concentrations: 6.1 mg/l in the logged, 4.7 mg/l in the burnt, and 5.2 mg/l in the reference groups (Figure IV.1);
- Mean C/N molar ratios: 12.4 in the logged, 11.6 in the burnt, and 11.8 in the reference groups of lakes (Figure IV.2);
- Mean MeHg concentrations in the SPM: 0.70 nmole/g dw in the logged, 0.96 nmole/g dw in the burnt, and 0.88 nmole/g dw in the reference groups of lakes (Figure IV.3).

These group mean values were not significantly different in statistical terms at the 95% confidence level (significance level $p > 0.05$). The difference was still insignificant when comparing only the burnt against the reference or the logged against the reference groups. For the logged group, the difference remained insignificant even when only those lakes whose watershed area was over 40% logged were considered. The absence of significant among-group differences indicates that the time elapsed since the deforestation disturbance may not have been sufficient for the observation of its full effects upon the water column SPM.

Comparing the epilimnion and hypolimnion samples, SPM concentrations were usually higher in the epilimnion than in the hypolimnion (Figure IV.4). In contrast, the C/N molar ratios were lower in the epilimnion than in the hypolimnion for all lakes, except one belonging to the logged group (lake C29) and one lake of the reference group (lake N120) (Tables IV.1 through IV.3), although the C/N ratio values for these two lakes do not greatly differ from the others, the difference lying within analytical error. One possible reason for the lower C/N molar ratios in the epilimnion (photic zone) is the presence of live material, which has a low C/N ratio, as a component of the SPM. Since

biological production is restricted to the photic zone, the presence of living organisms in the SPM of the hypolimnion would be comparatively negligible. MeHg concentrations in the SPM are larger in the epilimnion than in the hypolimnion in the burnt group of lakes. Conversely, for the reference and the logged groups of lakes, the SPM is richer in MeHg in the hypolimnion than in the epilimnion (Figure IV.5).

1.2. Methylmercury in the water samples

The dissolved MeHg concentrations in the water samples collected in September 1997 are reported in Table IV.4. Concentrations were always larger in the filtered water samples than in their unfiltered analogues, whenever both were available. Since the author did not take part in the fieldwork, it is possible that samples were contaminated during filtration or in another stage of the field processing. In order to circumvent this problem, the methylmercury contributed by the SPM was subtracted from the concentration in the unfiltered water sample. This should provide a good approximation to the dissolved methylmercury concentration in the water samples.

1.3. Dissolved organic carbon (DOC)

Mean DOC concentrations in the water column (Table IV.5; Figure IV.6) varied among the three groups of lakes in the following order: logged (7.4 mg/l) > burnt (6.4 mg/l) > reference (5.1 mg/l). The three treatment groups were significantly different at the 95% confidence level for the natural logarithms of the DOC concentrations ($p=0.014 < 0.05$). The fact that mean water column DOC is highest in the logged group of lakes is directly associated with the greater abundance of onsite post-logging residue to be degraded. This degradable material and its decomposition products (mainly DOC) are carried along the clear-cut watershed with surface runoff towards the receiving lakes. Since only one measurement was taken in each lake, it was impossible to compare its depth dependence, more specifically differences between epilimnion and hypolimnion.

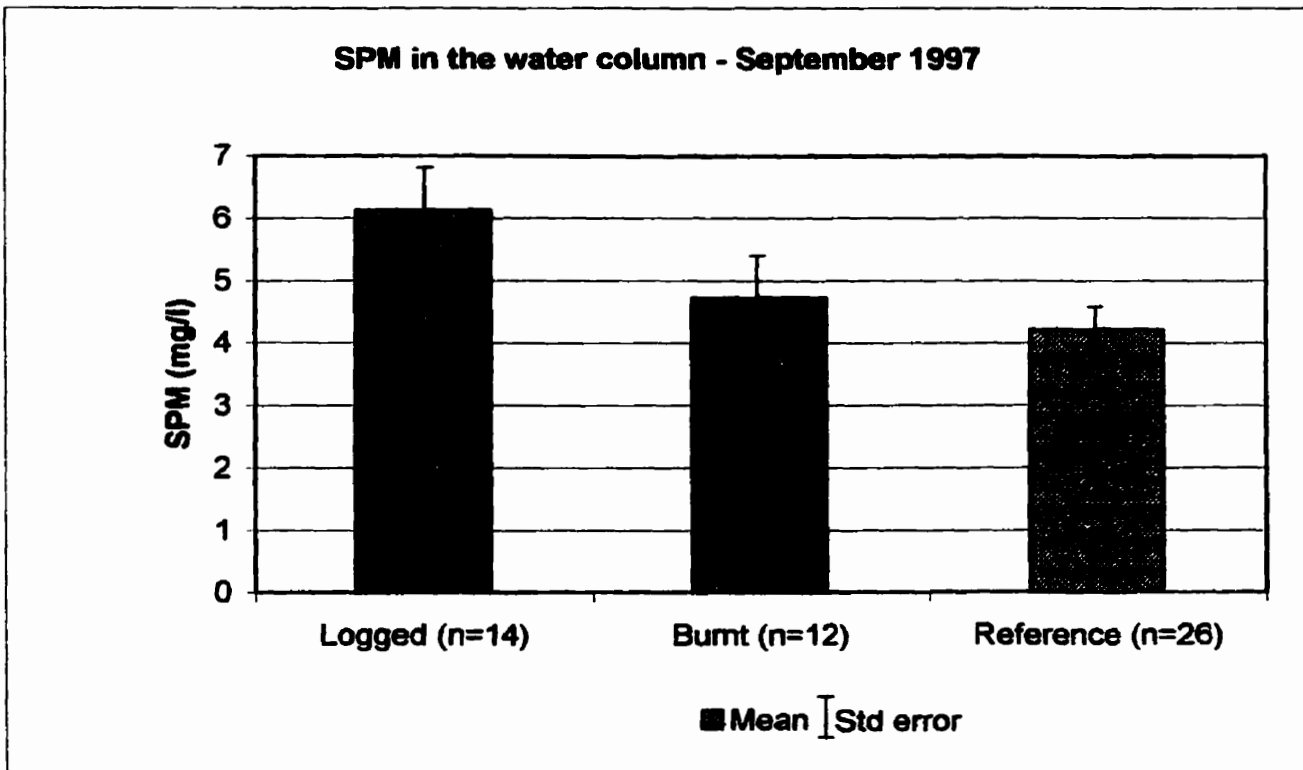

Figure IV.1: Concentrations of SPM in lake water column in September 1997

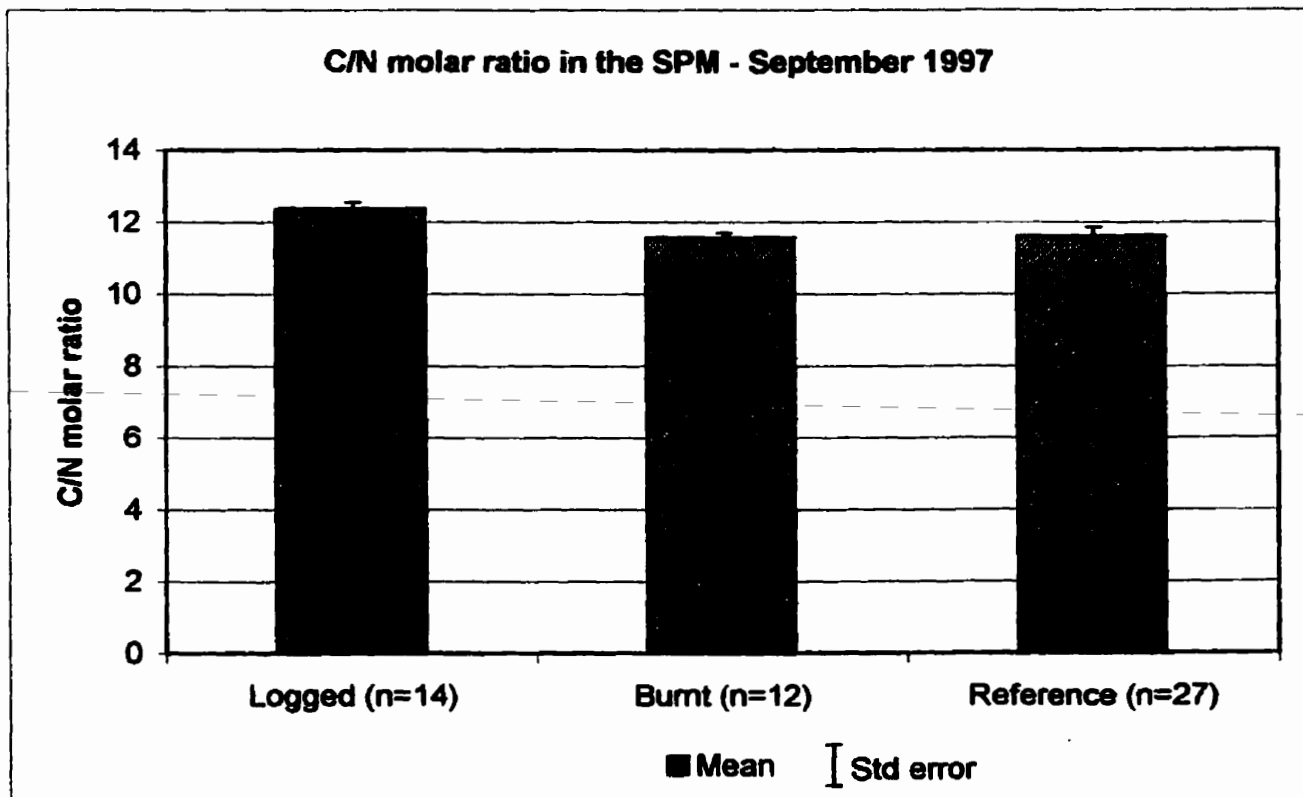

Figure IV.2: C/N molar ratios in the SPM in September 1997

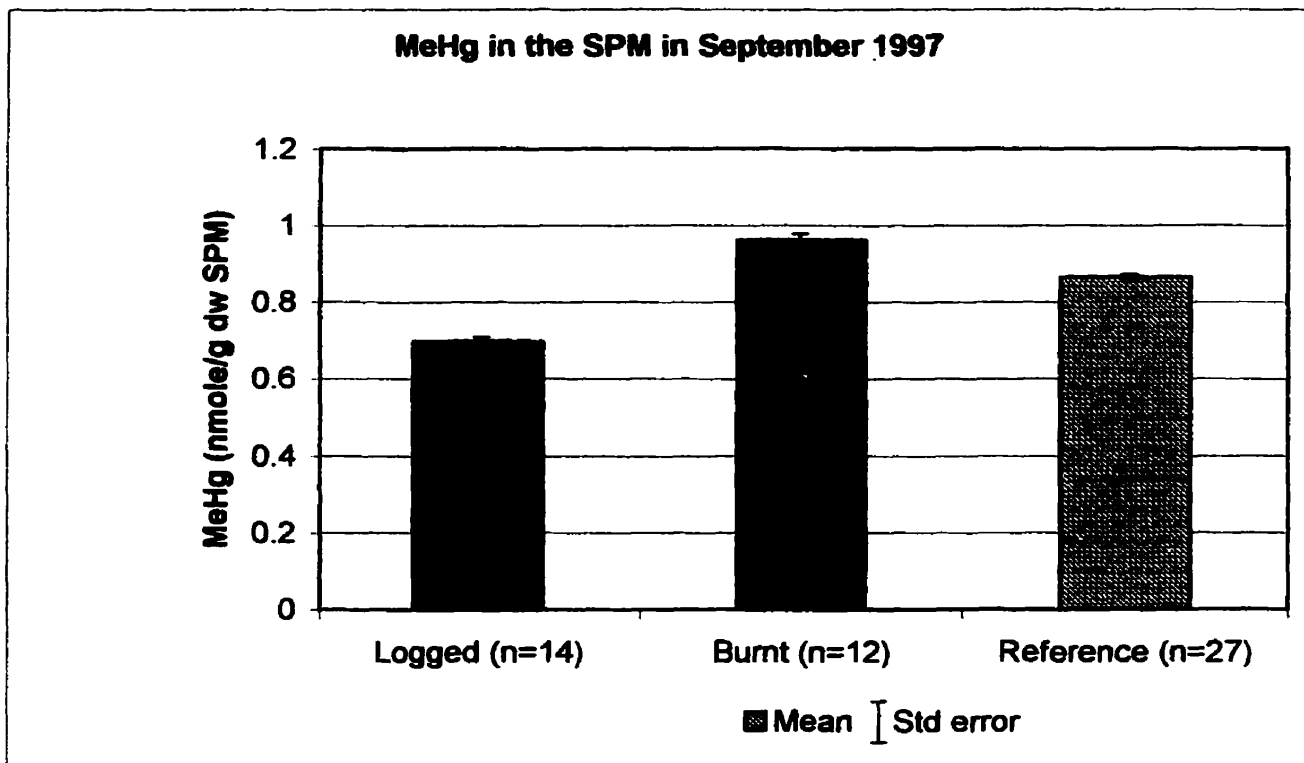

Figure IV.3: Concentrations of MeHg in the SPM in September 1997

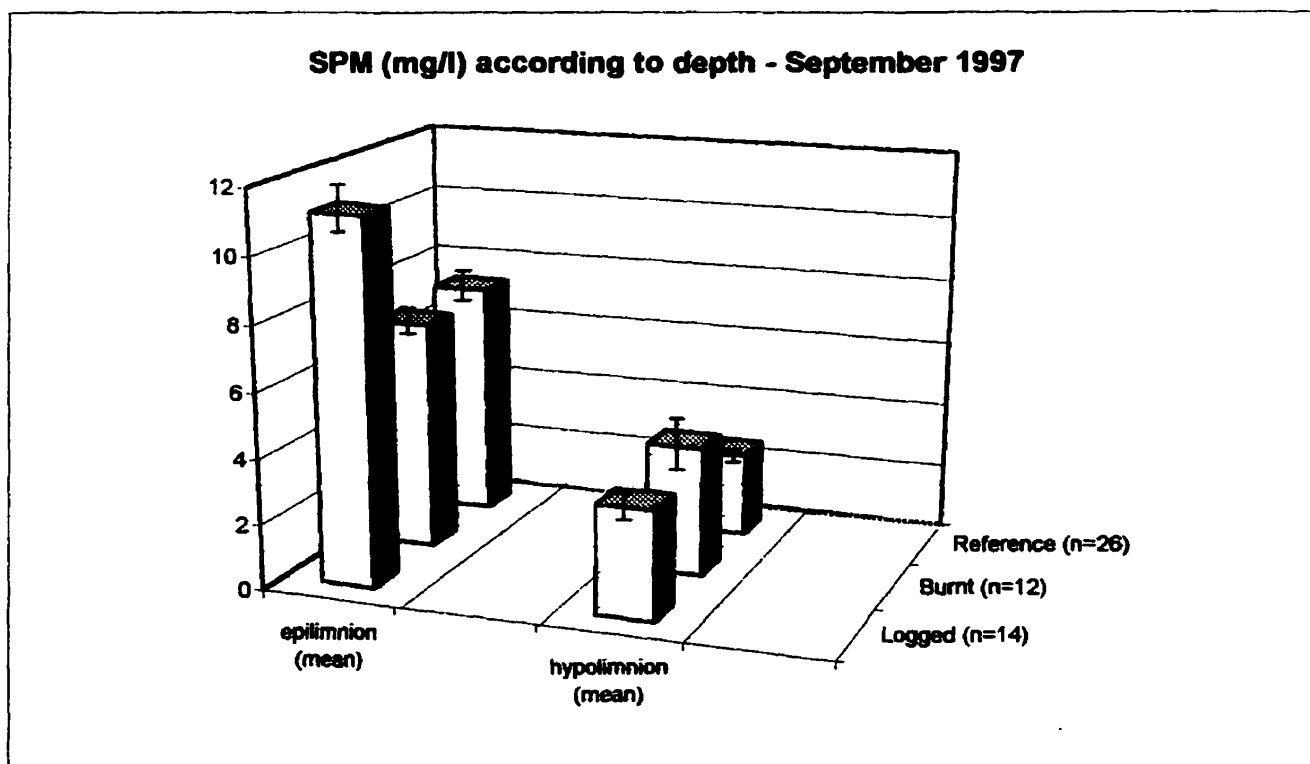

Figure IV.4: Concentrations of SPM according to depth in the water column of the stratified lakes in September 1997

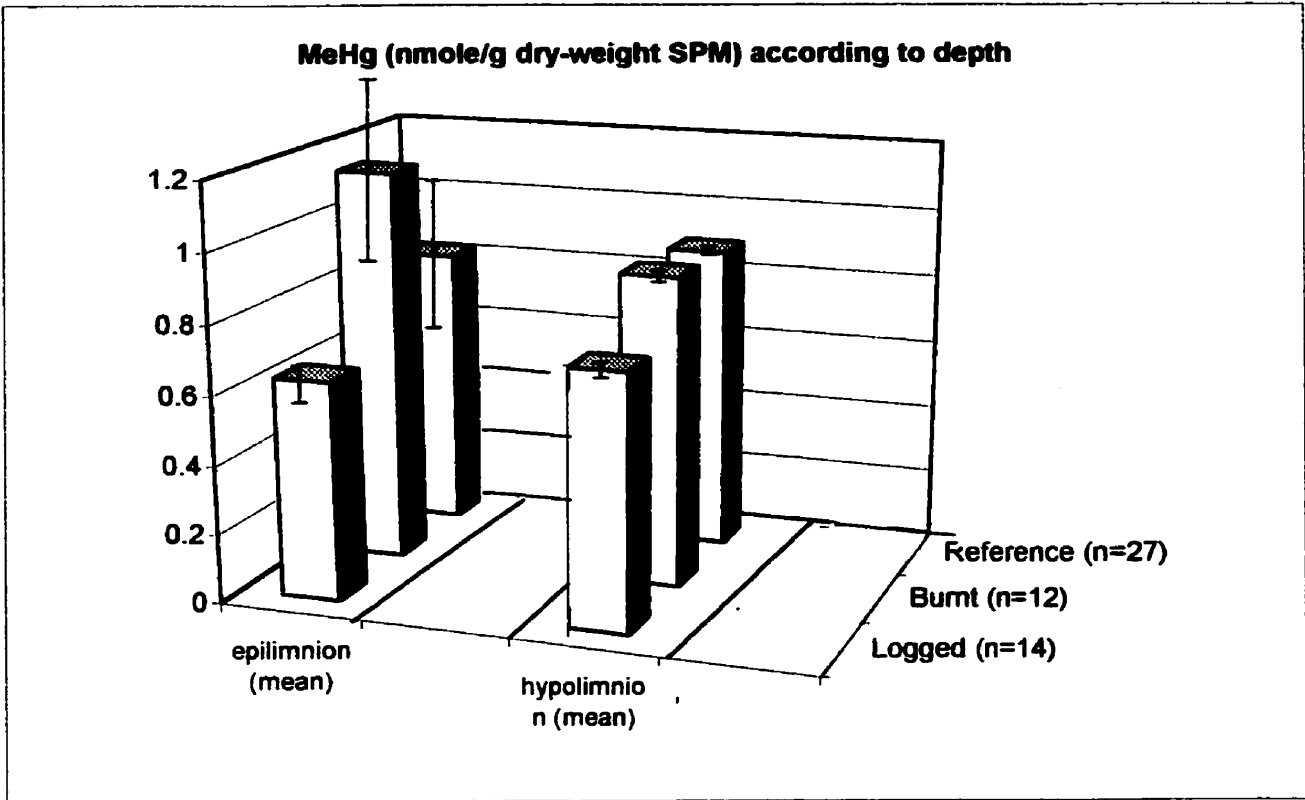

Figure IV.5: Concentrations of MeHg in the SPM according to depth in the water column of the stratified lakes in September 1997

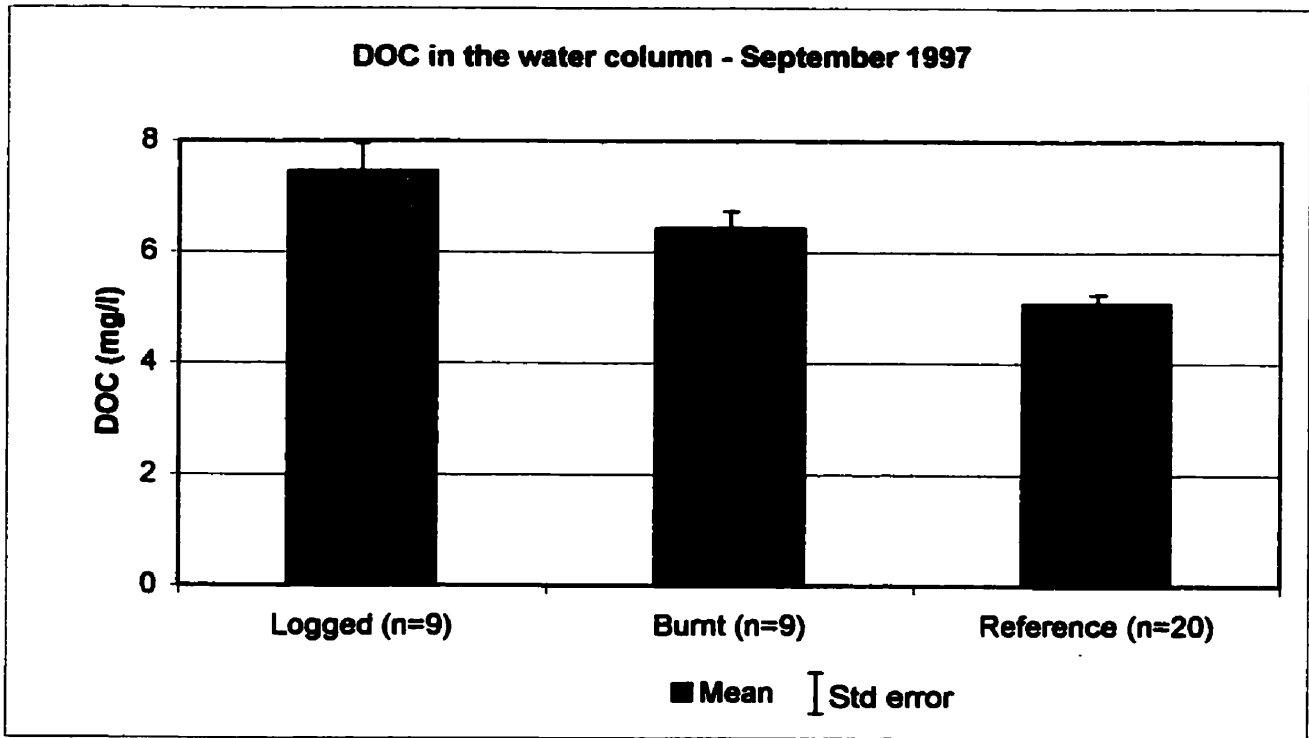

Figure IV.6: DOC concentrations in lake water column in September 1997

1.4. Other elements and ions

Table IV.6 shows group mean concentrations of sodium, potassium, calcium, magnesium, chloride and sulfate ions in lake waters collected in September 1997. Mean concentrations of all ions, except sodium, were higher in the burnt group than in the logged group of lakes. Mean concentrations were lowest in the reference group of lakes for all of the above ions, except sulfate (0.84 mg/l in the reference group and 0.80 mg/l in the logged group of lakes) and calcium. For the latter, concentrations in the logged group (0.43 mg/l) and the reference group (0.42 mg/l) were practically the same in view of the 0.01 standard error of the mean. Mean concentrations of total nitrogen, ammonium and nitrate were highest in the burnt and lowest in the reference groups of lakes.

Mean hydrogen ion concentrations were 0.79 $\mu\text{eq/l}$ in the logged, 0.54 $\mu\text{eq/l}$ in the burnt, and 0.74 $\mu\text{eq/l}$ in the reference groups of lakes. These concentrations correspond to mean pH values of 6.18 in the logged, 6.56 in the burnt, and 6.20 in the reference groups of lakes. The differences in group mean pH values were not statistically significant at the 95% confidence level ($p > 0.05$).

2. May 1998

2.1. Methylmercury in the filtered water samples

In May 1998, all lakes had their water column sampled, except two in the reference group (i.e., N16 and N35) which were not accessible to the hydroplane. One logged lake sample (C9) was lost due to analytical problems in the laboratory. The concentrations of dissolved MeHg were significantly higher in the logged (22.8 pmole/l) than in the burnt (9.3 pmole/l) and reference (10.5 pmole/l) groups of lakes (Table IV.7; Figure IV.7). The mean methylmercury (MeHg) concentration in the logged group is significantly higher than in the two other groups. Outliers N82 and N84 were excluded from the reference lakes for the calculation of the mean and variance, due to their large deviations from the mean. These deviations probably resulted from contamination during sample processing.

2.2. DOC

Mean DOC concentrations in the water column in May 1998 (Table IV.8; Figure IV.8) followed the same pattern as in September 1997, i.e., logged (6.4 mg/l) > burnt (6.1 mg/l) > reference (4.9 mg/l). Again the higher mean DOC concentrations in the water column of the logged group of lakes is associated with the greater availability of residual material on clear-cut areas and the increased surface runoff. The logged ($p=0.158$) and the burnt ($p=0.135$) groups did not differ significantly from the reference group at $\alpha=0.05$. However, when the lakes whose watersheds were less than 40% logged were excluded from the analysis, the difference between the logged and the reference groups became significant ($p=0.031$). Compared to September 1997, DOC concentrations in May 1998 are generally lower, which may be attributed to lower temperatures and increased discharge in May (spring) than in September (summer).

2.3. Other ions and elements

Group mean concentrations of potassium, calcium, magnesium, chloride and sulfate ions in lake waters collected in May 1998 were highest in the burnt group and lowest in the reference group of lakes. Mean sodium concentrations were highest in the logged group and lowest in the reference group of lakes (Table IV.9). Lake water column concentrations of total nitrogen, ammonium, and nitrate were higher in May 1998 than in September 1997 for all three groups. Nevertheless, they follow the same trends, with the highest concentrations observed in the burnt group and the lowest ones in the reference group of lakes.

Mean hydrogen ion concentrations were 0.71 $\mu\text{eq/l}$ in the logged, 0.60 $\mu\text{eq/l}$ in the burnt, and 0.77 $\mu\text{eq/l}$ in the reference groups. These concentrations correspond to mean pH values of 6.19 in the logged, 6.28 in the burnt, and 6.16 in the reference groups of lakes. The differences in group mean pH values were not statistically significant ($p>0.05$). This is consistent with the observations of September 1997.

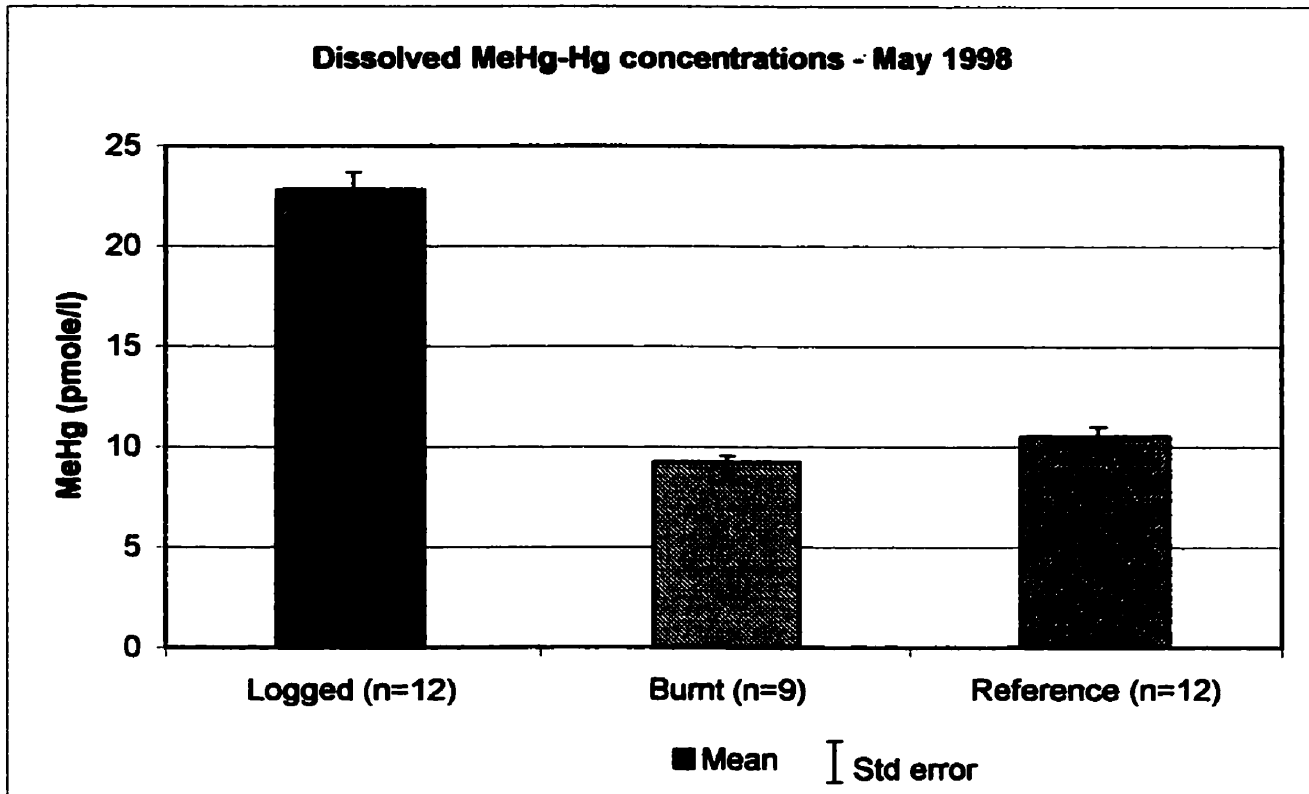

Figure IV.7: Dissolved MeHg concentrations in the water samples collected in May 1998

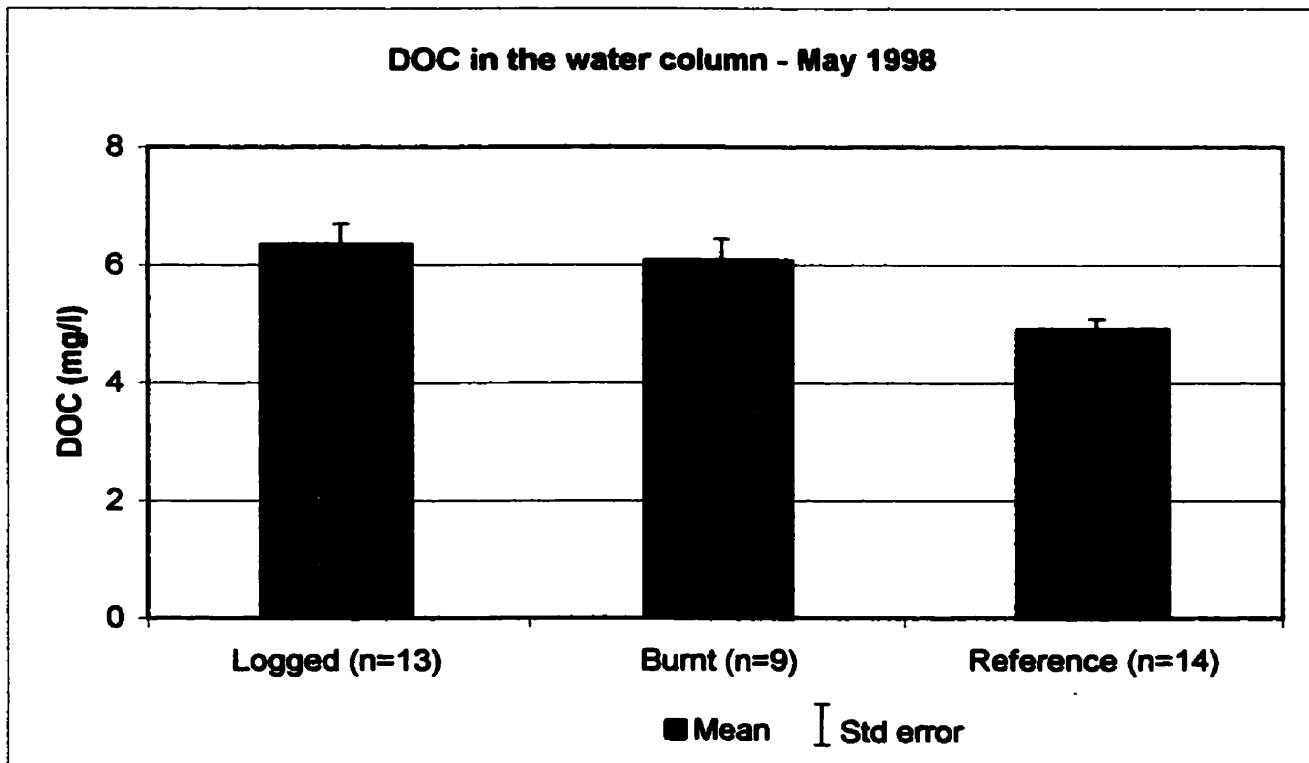

Figure IV.8: DOC concentrations in lake water column in May 1998

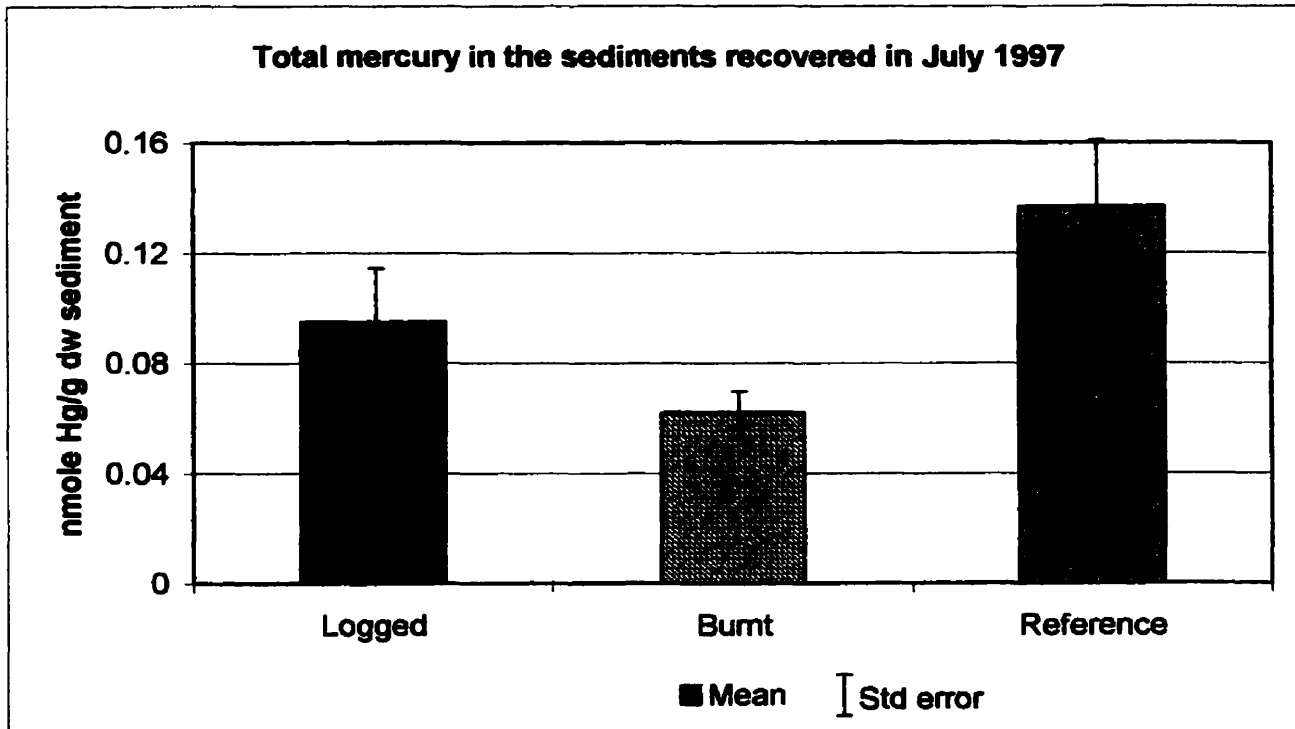

Figure IV.9: Total mercury concentrations in nmoles/g dry-weight in the bottom sediments recovered in July 1997

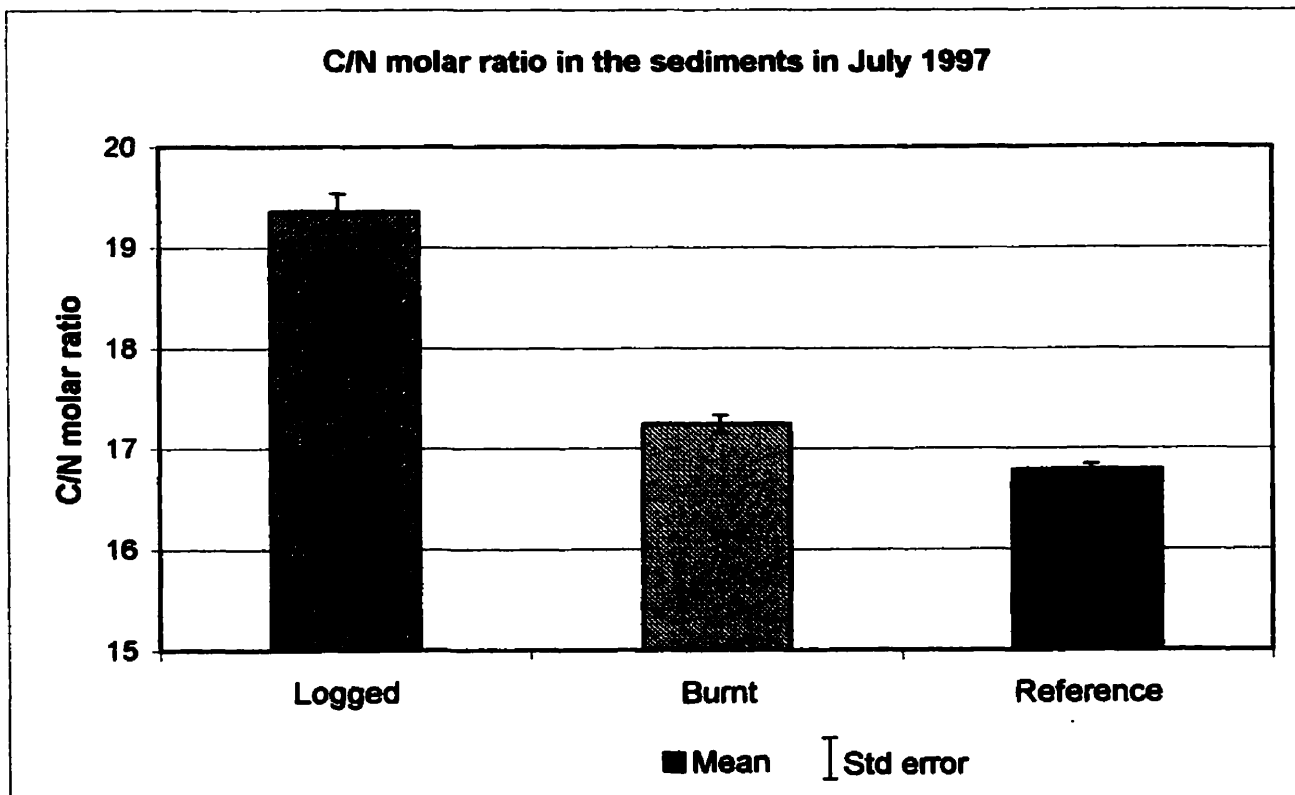

Figure IV.10: C/N molar ratios in the bottom sediments recovered in July 1997

3. Total mercury in the sediments recovered in July 1997

Individual surficial lake bottom sediment C/N molar ratios and total mercury concentrations are given in Tables IV.10 and IV.11. Figure IV.9 shows the mean concentrations of total mercury in the surficial (floc) lake bottom sediments of each treatment group: 0.10 nmole/g dw in the logged, 0.06 nmole/g dw in the burnt, and 0.14 nmole/g dw in the reference groups of lakes. Figure IV.10 shows the group mean carbon-to-nitrogen molar ratios of the sediments: 19.4 in the logged, 17.3 in the burnt, and 16.8 in the reference groups of lakes. The differences among group means were not statistically significant at the 95% confidence level.

B. Within-group differences

1. Morphometric parameters

1.1. Methylmercury in the SPM

Reference: For the reference lakes, two morphometric parameters contribute significantly to the stepwise regression model. These two are lake area ($p=0.042$) and lake perimeter ($p=0.032$). If taken individually (although, as mentioned above, they are not truly independent variables), they would explain 11.6% ($r=0.340$) and 13.0% ($r=0.361$), respectively, of the variation in SPM methylmercury contents. A third parameter, lake volume, came close to significance, with $p=0.055$ and $r=0.315$.

Logged: For the logged group, although catchment area/lake area and residence time explain larger proportions of the variability than the remaining parameters, their contribution is not statistically significant ($p>0.05$). Instead, 13 parameters together uniformly explain 45 % of the variation, with Pearson's correlation coefficients (r) ranging between 0.1 and 0.3, negative or positive. These parameters are: lake altitude, lake area, lake perimeter, latitude, mean littoral slope, longitude, lake maximum depth, lake mean depth, shore density, sampling depth, sum of wetland areas, mean catchment slope, lake volume.

Burnt: For the burnt groups of lakes, although lake mean slope explains more of the variability ($r=0.401$) than any other parameter, its contribution is not statistically significant ($p>0.05$). This is because 12 other parameters uniformly share 44 % of the

variation, with individual Pearson's correlation coefficients ranging between 0.1 and 0.3, again negative or positive. These 12 parameters are: watershed area/ lake area, drainage density, lake area, lake perimeter, latitude, mean littoral slope, longitude, shore density, sampling depth, catchment perimeter, mean catchment slope, lake volume.

All: Including all lakes in the regression model, mean catchment slope is the only significant morphometric parameter ($p=0.037$), explaining alone 25.1% of the variability in methylmercury concentrations in the SPM.

1.2. Dissolved MeHg concentrations in lake water column (May 1998)

Reference: For the reference lakes, three parameters contribute significantly to the stepwise regression model. These are, in increasing order of significance (decreasing p-significance level): mean littoral slope ($p=0.043$), maximum depth ($p=0.040$), and mean depth ($p=0.016$). Alone, mean depth would explain 33.2% of the variability in the dissolved MeHg concentrations ($r=0.576$) of the reference lakes.

Logged: For the logged group of lakes, although four morphometric parameters (namely drainage density, mean littoral slope, lake maximum depth, and lake mean depth) seem to significantly contribute to the regression model, none of them is statistically significant ($p>0.05$). The reason for this is the fact that 14 other parameters have Pearson's correlation coefficients (r) ranging between 0.1 and 0.3 (negative or positive), indicating the variability is uniformly distributed among these morphometric parameters. Drainage density ($r=0.466$) is the parameter closest to statistical significance ($p=0.063$).

Burnt: For the burnt group of lakes, littoral slope ($r=0.57$) and drainage density ($r=0.54$) are almost significant, with ($p=0.07$ and $p=0.08$, respectively).

All: When all lakes are included in the regression model, only littoral slope ($p=0.026$, $r=0.337$) and mean depth ($p=0.045$, $r=0.295$) become significant.

1.3. Total mercury concentrations in the surficial bottom sediments

Reference: For the reference lakes, no morphometric parameter is statistically

significant.

Logged: For the logged group of lakes, the only significant parameter is the ratio of watershed area to lake area ($p=0.016$), which alone would explain 50.3% ($r=0.709$) of the variability in total mercury concentrations, again showing the importance of surface runoff.

Burnt: For the burnt group, the following parameters are significant (given in order of decreasing significance, i.e., increasing p-level): watershed area ($p=0.001$), catchment area, stream length, water flow ($p=0.002$), catchment perimeter ($p=0.004$), sum of wetland areas ($p=0.007$), and altitude ($p=0.042$). A model including catchment area alone would explain 79.2% of the variance of sediment total mercury contents ($r=0.890$), whereas a model including only watershed area would explain 80.5% of the variability ($r=0.897$).

All: Including all lakes in the stepwise regression model, mean depth is the only significant morphometric parameter ($p=0.048$). The negative contribution of altitude is nearly significant ($p=0.052$).

2. Lake water chemical parameters

Reference: For the reference lakes, two chemical parameters are significant towards the stepwise regression model. These two parameters are calcium ($r^2=0.271$; $p=0.041<0.05$), and chlorophyll-a ($r^2=0.476$; $p=0.007<0.05$) concentrations. The strong correlation with chlorophyll-a concentration may be related to methylmercury association with microplanktonic algae (Boudou and Ribeyre, 1981; Darnall et al., 1986; Jackson, 1986). Jackson (1986) found a strong positive correlation between chlorophyll-a and methylmercury concentrations in lake water.

Logged: In the logged group of lakes, chlorophyll-a concentration is the chemical parameter closest to statistical significance ($r^2=0.171$; $p=0.091>0.05$), but the correlation is negative ($r=-0.413$). This appears to be linked to the well documented phenomenon of mercury and methylmercury scavenging by increased productivity. In the burnt group of lakes, potassium ion concentration is the parameter that comes closest to statistical significance ($r^2=0.262$; $p=0.079>0.05$).

Burnt: Like chlorophyll-a in the logged group, the potassium and dissolved methylmercury concentrations are negatively correlated in the burnt ($r=-0.512$) group, probably due to the loss of potassium through volatilization to the atmosphere during forest fires.

All: Including all lakes in the regression model, no parameter approaches statistical significance. All parameters can be said to uniformly account for the variation in the dissolved methylmercury concentrations, with the Pearson's correlation coefficients (r) varying between -0.2 and $+0.2$.

V – DISCUSSION

1. Suspended particulate matter (SPM)

Several authors report a significant increase in the catchment export of SPM after clear-cutting (Patric, 1980; Van Lear et al., 1985; Beasley et al., 1986; Roberts and Church, 1986; Malmer, 1990), which can be attributed to two main causes: the greater abundance of on-site post-logging organic residue, which consists predominantly of plant fragments and their breakdown products (see section V.1.2 below), and the intensified surface runoff (see section V.1.3 below). The latter may remove considerable amounts of particles by eroding the impacted, exposed soil (see section V.1.4 below). Mean SPM concentrations in the water column in September were 6.1 mg/l in the logged, 4.7 mg/l in the burnt, and 5.2 mg/l in the reference groups of lakes (Figure IV.1). These values are not significantly different in statistical terms (refer to section IV.1.1), which may indicate that the clear-cutting and forest fire disturbances are too recent, not yet having completely manifested their impacts on the SPM component of our lakes.

In contrast to forest fires, clear-cutting often completely removes the vegetation of an area. In some cases where undergrowth vegetation exists it may be left behind. However, in most forests, closed canopies of the original trees prevent the development of any undergrowth (Likens et al., 1970; Bergeron, 1991; Hunter, 1993; Carleton and McLellan, 1994; Berdén et al., 1997). Thus, as a consequence of clear-cutting, the forest floor is completely exposed, and the top soil is usually compacted, revolved and/ or mixed with the underlying soil layers. The use of heavy machinery in the logging operation may also remove the soil duff layer (Thomas, 1975a,b, Groot, 1987; Keenan and Kimmins, 1993; Jewett et al., 1995). According to Ash (1995), soil A-horizons may be partially or completely missing in clear-cut areas.

The spatial extent of soil compaction and revolving varies considerably with the logging method (Keenan & Kimmins, 1993). Tractors, for instance, may expose the soil B-horizon of 40% of the logged area (Froelich, 1988), whereas for other techniques (e.g., skyline yarding and balloon and helicopter logging) the disturbance may be restricted to only 5% of the area (Ruth, 1967; Bockheim et al., 1975). Compaction reduces the porosity and water permeability of the soil. The ensuing water saturation in the soil greatly intensifies the surface runoff and prevents the percolation of water and solutes

through the soil profile (see section I.2.2.1). This affects not only the water cycling in the soils, but the whole hydrologic cycle, altering the movements of liquid water and vapor in the atmosphere, groundwater, surface runoff, and lakes. As a consequence, their chemical properties are also affected (Langmuir, 1997).

The intensified surface runoff after clear-cutting removes important amounts of particles from the exposed, unstable soil (Brown et al., 1973). In the streamwater of disturbed forest catchments, fine particles (less than 1 mm in diameter) that have been eroded remain suspended because of the increased water flow and turbulence, causing water turbidity (Keenan and Kimmins, 1993). Since these particles are transported in suspension, catchments can supply large amounts of suspended and dissolved material, including mercury-rich terrestrial organic matter (Lee and Hultberg, 1990; Mierle, 1990; Lee and Iverfeldt, 1991; St. Louis et al., 1994a; Lucotte et al., 1995). Friedriksen (1971) observed that 54% of the total nitrogen and 17% of the potassium losses following clear-cutting were associated with the SPM.

Logging activities produce residual particulate organic matter of larger size and in greater abundance than fire, which breaks down residues and may even reduce them to ash (Carleton and McLellan, 1994; Brown et al., 1973). In clear-cut areas, chunks of wood and other plant fragments (e.g., branches, leaves, limbs, flowers, needles), as well as roots and lower portions of stems within the soil, are left on site (Brown et al., 1973; Seastedt and Crossley, 1981; Moore, 1989; Berdén et al., 1997). Therefore, clear-cutting mobilizes a much larger amount of terrestrial biomass than do forest fires. The differences between forest fire and clear-cutting do not end there. Even if logging is carried out at intervals that match the frequency of forest fires, if the slash is burnt to break down residues, and if uncut forest patches are left to reproduce unburnt fire skips, there would still be differences (Hunter, 1993). Among these differences are the loss of volatile elements with fire, and the differential impacts on the hydrologic cycle, soil geochemistry, and microbial populations, to name a few.

Turbidity is also an indicator of the rate of soil loss (Keenan and Kimmins, 1993) and particulate export. Both turbidity and SPM levels can potentially be increased by clear-cutting (Keenan and Kimmins, 1993). Brais et al. (1995) report a 44% to 55% reduction in forest floor dry weight after clear-cutting. This reduction is not due solely to

leaching and erosion, but to a combination of factors, including the accelerated decomposition of organic residues and the modifications in litter quality and availability, since litter is continually removed without replenishment (Brown et al., 1973; Likens et al., 1970; Covington, 1981; Federer et al., 1989; Shure and Phillips, 1987; Ash, 1995; Brais et al., 1995).

In summary, clear-cutting causes soil erosion in two different ways: by increasing the probability of overland flow, as a result of the higher soil water content; and by increasing the scouring of drainage channels and the sediment-carrying capability of surface streams (Patric, 1976; Keenan and Kimmins, 1993). Erosion rates depend on intrinsic soil properties such as texture (especially with respect to the proportion of low-granulometry particles), aggregate stability in water, and organic matter content, as well as on extrinsic factors such as slope, climate, vegetation cover (Dyrness, 1967; Feller, 1982). Characteristics of the clear-cutting method used also influence the extent of soil erosion (Sopper, 1975; Patric, 1976).

Apart from the deforestation effects, SPM concentrations usually show strong seasonal variation. In lakes studied by Hurley et al. (1994), mean particle mass was generally lowest under ice-cover (March) and increased throughout the ice-free period (April to November). The SPM in the water column of these lakes was predominantly allochthonous biogenic (i.e., exported from the catchment, mostly from forests) material, except in the fall overturn (September/ October). Unfortunately, no seasonal comparisons were possible in the present study, due to the lack of data. However, had SPM concentration data been available for May 1998, they would likely portray a seasonal difference from those of September 1997. Such a difference would be expected from variations in precipitation amount, water flow, and ice-cover, among others.

2. C/N ratios

The C/N ratio of a given material is a measure of the molar fraction of nitrogen relative to carbon present in its composition (Cole and Heil, 1981; Staaf and Berg, 1981). In contrast to the ubiquity of carbon in all environmental compartments, nitrogen is usually a limiting factor to biological productivity (Wetzel, 1992). For this reason, soil nitrogen contents are usually the primary determinants of the C/N ratios (Berdén et al.,

1997). When the soil is nitrogen-rich, the C/N ratio of its organic matter will be lower, and vice-versa.

The amount, availability and cycling of the major biogenetic elements impose serious constraints on the organization of the biosphere (Margalef, 1997). Accordingly, nitrogen, a major biogenetic element, strongly influences the decomposition rate of terrestrial biomass. The lower the C/N ratio of organic matter, the greater its susceptibility to decomposition (Cole and Heil, 1981; Staaf and Berg, 1981). According to Berg and Staaf (1981), litter can take up nitrogen from the environment, thus increasing its decomposition rate. This explains the observations that an increased nitrogen input to the soil results in the breakdown of organic compounds, reducing their molecular weight and increasing their mobility (Berdén et al., 1997).

Besides the C/N ratios, another factor that strongly affects the degradation rate of organic matter is its content of refractory material, specifically lignin, cellulose, starch and their decomposition products. These decomposition products are collectively named humic material, and their solubility is directly proportional to their nitrogen contents (Brady, 1984; Flaig et al., 1975; Kerndorff and Schnitzer, 1980; Rashid, 1985). Humic material is defined as organic matter altered by bacterial processes and usually depleted in easily metabolized nutrients. This depletion precludes further decomposition (Brady, 1984; Flaig et al., 1975). Although the composition of humic matter is not fixed, its main constituents are carbon, hydrogen, and oxygen, nitrogen being only a minor component, as well as sulphur and phosphorus (Flaig et al., 1975).

Terrigenous organic matter in general, and particularly forest litter, is predominantly composed of highly refractory material (Kaärik, 1974), such as lignin, a biopolymer present in the xylem of terrestrial plants. Lignin is highly refractory, i.e., its microbial degradation is very slow (Cole and Heil, 1981; Staaf and Berg, 1981; Killops and Killops, 1993). In fact, it is the last substance in litter to decompose, strongly delaying organic matter degradation (Berg and Staaf, 1981).

In addition to their refractory composition, logs, branches and other woody material have an exceptionally low nitrogen content (Kaärik, 1974). Thus the C/N ratio of terrigenous organic matter, including forest litter, is generally high, ranging from 10 to 100 (Cole, 1981; Granhall, 1981; Rashid, 1985), which contrasts with the much lower

C/N ratios of marine and freshwater autochthonous organic matter. For marine organic matter (i.e., algae), C/N molar ratios typically range between 5 and 15, due to the predominance of proteins which account for as much as 60% of the primary organic carbon (Rashid, 1985). Likewise, the C/N ratios of freshwater autochthonous material, largely consisting of living organisms, are also low, in view of the high levels of nitrogenated compounds present in living tissue (Lazerte, 1983).

Since most forests are nitrogen deficient, trees have developed a mechanism for translocating nitrogen from older to younger organs, according to their requirements (Cole, 1981). Therefore, photosynthetically active organs, whose primary production rates are high, will be enriched in nitrogen at the expense of older, less productive organs (Cole and Heil, 1981; Staaf and Berg, 1981).

Since nitrogen is such an important constituent of any biologic material, a mechanism exists as well to prevent nitrogen depletion and its deleterious consequences when the C/N ratio of organic matter is very high (e.g., above 20). Through this mechanism, termed nitrogen immobilization, nitrogen is retained in the organic matrix as decomposition proceeds and carbon is released (Kaärik, 1974; Berg and Staaf, 1981; Khanna, 1981). Therefore, the C/N ratio of the decomposing material progressively decreases, until it reaches a threshold level, where nitrogen starts to be released along with carbon by the decomposition process (Kaärik, 1974; Alexander, 1977). For this reason, organic matter degradation is a key factor in understanding the release of nitrogen to the environment (Van Veen et al., 1981) and its export from catchments.

Besides C/N ratios and lignin contents, the size and density of organic residues also negatively affect the decomposition rates (Cole and Heil, 1981; Staaf and Berg, 1981; Van Veen et al., 1981). According to the nature of post-disturbance on-site organic residues (see section V.1.1), all these factors are expected to be highest in the logged group of lakes. Therefore it is reasonable to assume lower relative decomposition rates in the logged group than in the burnt group of lakes. The primary breakdown of residues imposed by fire reduces the size of the particles and the complexity of organic compounds, facilitating and even stimulating microbial decomposition. Conversely, in the logged catchments, decomposition of organic matter would be relatively slower than in the burnt catchments and accompanied by nitrogen immobilization.

In fact, increased availability of slowly-decomposing organic residue (e.g., woody litter, decaying roots, and slash in general) has been shown to increase the extent of microbial nitrogen immobilization (Vitousek et al., 1979; Vitousek and Matson, 1985b). When clear-cutting procedures include the removal of on-site residues, nitrogen losses through leaching are increased, as nitrogen immobilization is reduced or prevented (Vitousek and Matson, 1985b) and more nitrogen is available for export from the catchment. Similarly, slash burning after clear-cutting also reduces or prevents nitrogen immobilization by breaking down the organic residue, resulting in increased release of nitrogen (Friedriksen, 1971; Brown et al., 1973).

As a consequence of the nitrogen immobilization in the logged catchments, the mean C/N molar ratio in the soil is expected to be higher than that in the lake water column SPM. The latter was calculated to be 12.4, by averaging across the lakes of the logged group (Figure IV.2). This reduction in the C/N molar ratio most likely occurs throughout the watershed, simultaneously with the export of residual material with surface runoff. Since nitrogen immobilization is not expected to take place in the burnt catchments, C/N ratios most likely did not change with export along the catchment for this group, remaining around the mean value of 11.6. Despite the progressive nitrogen immobilization of organic matter along the logged catchments, the corresponding in-lake mean C/N ratios in the SPM were not decreased below those of the burnt group of lakes (Figure IV.2). As a matter of fact, the mean SPM C/N molar ratios of both groups of lakes are statistically equivalent (refer to section IV.1.1), i.e., $p > 0.05$. Unfortunately, C/N molar ratios in the SPM were measured only within the lakes, and not along the catchment, which could confirm the hypothesis of nitrogen immobilization and document the gradient of the C/N molar ratio change.

The higher C/N molar ratios of the SPM in the hypolimnion relative to the epilimnion reflect the different nature of particles at the two depths. This is expected, especially for the lakes that were stratified at the moment of sampling. The higher C/N molar ratios at depth could be explained by the more rapid settling of larger, denser particles (probably subjected to less nitrogen immobilization) to the lake bottom. Nevertheless, the difference in the C/N ratios of the SPM between the hypolimnion and the epilimnion most likely results from the contribution of autochthonous suspended

particulate material in the latter. Since biological production is restricted to the photic zone (epilimnion), this autochthonous material mostly consists of living organisms, whose C/N ratio is typically low.

Another result of the nitrogen immobilization in the decomposing post-logging residue is the reduced loss of dissolved nitrogen by leaching in the logged catchments in comparison to the burnt catchments (Vitousek, 1981). In the burnt group of lakes, mean water column concentrations of total nitrogen (280 $\mu\text{g/l}$ in September 1997, and 300 $\mu\text{g/l}$ in May 1998) and, most of all, nitrate (26 $\mu\text{g/l}$ nitrate in September 1997, and 30 $\mu\text{g/l}$ in May 1998) are much higher than those in the logged group (220 $\mu\text{g/l}$ total nitrogen and 3.4 $\mu\text{g/l}$ nitrate in September 1997; 235 $\mu\text{g/l}$ total nitrogen and 13 $\mu\text{g/l}$ nitrate in May 1998) and the reference group (190 $\mu\text{g/l}$ total nitrogen and 1.7 $\mu\text{g/l}$ nitrate in September 1997; 215 $\mu\text{g/l}$ total nitrogen and 10 $\mu\text{g/l}$ nitrate in May 1998) of lakes (Tables IV.7 and IV.10).

3. Dissolved organic carbon (DOC)

Clear-cutting and forest fires stimulate organic matter decomposition in the soil and surface runoff as compared to undisturbed sites (Vitousek, 1981; Moore, 1989; Brais et al., 1995). According to Berdén et al. (1997), the mineralization of fresh decomposable organic matter from the disturbed sites leads to intense production of DOC. Accordingly, DOC concentrations in runoff and soil solution increase. This explains why the mean DOC concentration is significantly higher (refer to sections IV.1.4 and IV.2.2) in the logged group (7.4 mg/l in September 1997; 6.4 mg/l in May 1998) and in the burnt group (6.4 mg/l in September 1997; 6.1 mg/l in May 1998) than in the reference group (5.1 mg/l in September 1997; 4.9 mg/l in May 1998) of lakes (Figures IV.6 and IV.8).

The higher mean DOC concentration in the logged as opposed to the burnt group of lakes is explained by the greater abundance, in the logged watersheds, of substrate (i.e., organic residues to be degraded) (Hinton et al., 1997) and its refractory nature (section 2.2). The larger the amounts of decomposable slash left on site, the greater the leaching of both particulate and dissolved organic carbon (Khanna, 1981; Vitousek and Matson, 1985a; Hendrickson et al., 1989; Smethurst and Nambiar, 1990; Keenan and Kimmins, 1993). Covington (1981) reports a 15% decline in soil organic matter over the

first 15 years following clear-cutting in northern hardwoods. Moreover, forest fire may consume some or all of the organic soil layers of the forest floor from the top down (Flinn and Weinn, 1977; Carleton & McLellan, 1994), further decreasing the potential for DOC production in the burnt catchments in contrast to the logged group of lakes.

According to Cronan and Aiken (1985), watershed DOC mostly originates through leaching and microbial decay in the upper soil profile. In forests, large quantities of nitrogen and carbon are tied up in structural organs of the trees. Through decomposition, these are eventually transferred to the soil (Staaf and Berg, 1981). Root systems of most coniferous forests and hardwood species, which do not resprout from fragments, die and decay after clear-cutting (Keenan and Kimmins, 1993). Leaching experiments have shown that 25% or more of the carbon in leaves can be lost within one week (McDowell and Fisher, 1976).

Mean DOC concentrations in the water column in May 1998 did not differ significantly across groups when all lakes were included in the statistical analysis. However, the among-groups difference was significant ($p < 0.05$) when the lakes whose watershed areas were less than 40% clear-cut were excluded from the test. This emphasizes the importance of the extent of the disturbance, indicating that at least 40% of the forested area of the watershed needs to be directly affected by clear-cutting before its effects are fully detectable.

In the logged group, DOC concentrations in lake water column are lower in May 1998 (6.3 mg/l -Figure IV.8) than in September 1997 (7.4 mg/l -Figure IV.6). This probably reflects the influence of the spring thaw, when large amounts of water from the melting of ice and snow dilute the dissolved material in lake water and in soil percolates (Jewett et al., 1995; Bishop et al., 1995; Pettersson et al., 1995; Rosén et al., 1996). Pettersson et al (1995) observed a decrease in both pH and DOC levels in lake waters with the spring flood, after which they increased through the summer and autumn. Similarly, Jewett et al. (1995) found streamwater sodium, calcium and magnesium concentrations to be lowest in the spring. A negative correlation between discharge and DOC has been observed in several catchments (Mulholland, 1981; Naiman, 1982; Clair and Freedman, 1986; Freedman and Clair, 1987; Moore and Jackson, 1989). However, this is not true during the snow-free season, when increased discharge does not cause

dilution of DOC, but, instead, leads to an increased discharge of organic matter from the soil (Meyer and Tate, 1983; Moore, 1989; Eckhardt and Moore, 1990; Bishop et al., 1995; Pettersson et al., 1995; Hinton et al., 1997; Schiff et al., 1997). A positive correlation with stream discharge may also be observed when the substances involved are chiefly adsorbed or otherwise associated with the stream particulate load, which generally increases with discharge (Langmuir, 1997).

The lower DOC concentrations in May 1998 than in September 1997 may also be explained by the dependence of microbial decomposition on temperature. Since temperatures are on average lower in spring (May) than in summer (September), decomposition rates would be equally lower, generating less DOC (Johannesen and Henriksen, 1978; McColl, 1972; Feller and Kimmins, 1984; Cronan and Aiken, 1985). Cronan and Aiken (1985) observed higher DOC concentrations in soil leachates in summer than in winter. An elevation in stream temperatures following clear-cutting results from an increase in direct solar radiation reaching the stream surface, now deprived of a vegetation cover. Maximum summer temperatures at soil level may be increased by more than 10°C, and in the winter and early spring by 2° to 3°C (Keenan and Kimmins, 1993).

In the boreal forest temperature is a very important factor, conditioning all biogeochemical aspects of the system structure and function (Van Cleve and Alexander, 1981). Temperature influences the decomposition rate by regulating the degree of microbial activity. Also important is ultraviolet radiation bleaching (Kleber et al., 1990). Other factors affecting microbial decomposition are pH, water availability, and the availability and reactivity of carbon and nutrients. Higher pH and temperatures, and larger amounts of water, reactive carbon, nitrogen and phosphorus promote increased organic matter degradation (Swift et al., 1979; Cole and Heil, 1981; Covington, 1981; Staaf and Berg, 1981; Van Veen et al., 1981; Woodmansee and Wallach, 1981; Berdén et al., 1997). Microbial activities are increased even further when reduced rates of infiltration due to soil compaction keep water at the surface, especially in shallow areas of the watershed. During summer, decomposition would be greatly intensified within puddles and in soils adjacent to these standing water bodies (Insam, 1990; Jewett et al., 1995).

4. Methylmercury in the water column

An analysis of the data set on methylmercury concentrations in the water column, reveals that (a) for the dissolved phase, concentrations are significantly ($p < 0.05$) higher in the logged group (22.8 pmole/l) than in the burnt (9.3 pmole/l) and reference (10.5 pmole/l) groups of lakes (Figure IV.7); (b) in the SPM, mean methylmercury concentrations are higher in the burnt group (0.96 nmole/g dw SPM) than in the logged (0.70 nmole/g dw) and reference (0.88 nmole/g dw) groups of lakes (Figure IV.3). However, these differences in methylmercury concentration in the SPM are not statistically significant ($p > 0.05$).

DOC and dissolved methylmercury concentrations in the water column (see section V.3.1) are concomitantly higher in the logged group of lakes, which suggests the existence of a relationship between the DOC and the dissolved methylmercury. This relationship could result from three different processes or their combination: (a) methylmercury may be exported from the catchment in association with the DOC, as a result of the surface runoff intensification; (b) the higher DOC concentrations may stimulate the in-lake microbial methylation activity, resulting in increased production of methylmercury from inorganic mercury exported from the catchment in association with the DOC; (c) equilibrium partitioning of methylmercury between the particulate and dissolved phases may result in higher methylmercury levels as a result of increased DOC concentration.

4.1. Associated export of methylmercury and DOC

Both dissolved and particulate humic matter from exposed soils are considered as important carriers of mercury species to streams and lakes (Benes et al., 1976; Lodenius et al., 1983; Mierle and Ingram, 1991). According to Meili (1992), allochthonous humic matter concentrations determine water color in boreal lakes and streams, and both humic matter and water color are related to mercury concentrations. For instance, total mercury concentrations in surface waters are around 1 ng/l (5 pmol/l) in clearwater lakes (Hurley et al., 1991; Meili, 1991c) and may exceed 5 ng/l (25 pmol/l) in humic lakes (Meili et al., 1991). According to Lee and Hultberg (1990), the concomitant increase in the concentrations of DOC and dissolved methylmercury in lake water column reflects

efficient export from the catchment. Similarly, Johansson and Iverfeldt (1991) proposed that mercury concentrations in runoff are dependent on the concentrations of humic matter and its degree of association (i.e., affinity) with mercury. The difference between the logged and the burnt groups would be in the amount of organic carbon mobilized and exported, which, in turn, would determine the quantity of mercury and methylmercury delivered to the lakes.

Thérien and Morrison (1986) have proposed a model to explain the behavior of mercury and organic matter following soil impoundment. This model can be adapted for watershed deforestation, since both perturbations have in common the increased soil water contents and the leaching losses that ensue. According to the model, from the original organic material (TOMF) present on the impacted site, immediate losses can occur in three forms: particulate (POM), refractory or humic (HOM) and labile (DOM) organic matter. The remainder of the TOMF is slowly converted to POM, which is further attacked, producing DOM and HOM. The latter two components are microbially degraded, consuming oxygen (O_2) and producing carbon dioxide (CO_2), as well as liberating ammonium and phosphate. The ammonium is nitrified to nitrate in the presence of oxygen. Dissolved inorganic mercury is released proportionally to DOM and HOM. Methylmercury is assumed to be initially absent, being microbially produced from the released inorganic mercury. Demethylation converts part of the methylmercury back to the inorganic form. Both mercury species can be lost from solution through volatilization and sorption to particles. Dissolved metabolite concentrations are influenced by water levels and by the availability of particulates and original material (TOMF) to be degraded (Thérien and Morrison, 1986).

Obviously, this model is an over-simplification of the behavior of organic matter and mercury in the soil after disturbance, since it considers methylmercury to be initially absent and neglects a number of other processes. Nevertheless, the model still portrays important relationships, primarily the concomitant release of organic matter and mercury (Andersson, 1979; Lindqvist et al., 1991; Mierle and Ingram, 1991; Schuster, 1991; Xiao et al., 1991; Krabbenhoft and Babiarz, 1992). Even the assumed initial absence of methylmercury in the soil is not totally unreasonable. Compared to those of inorganic mercury, the concentrations of methylmercury detected in a soil profile are usually very

low, sometimes 50 times lower (Chaire de recherche en environnement, 1993; Mucci et al., 1995). Although in essence incompatible with the hypothesis of increased methylmercury export from the watershed, the assumption of initial absence does not invalidate the fact that most or all of the inorganic mercury may originate from the catchment and that part of it could be methylated during transport, before it eventually reaches the lakes.

4.2. Stimulated methylation

As proposed in the model of Thérien and Morrison (1986), the decomposition of particulate organic matter (POC), besides releasing DOC, stimulates the process of mercury methylation (McMurtry et al., 1989). According to Compeau and Bartha (1985), microbial methylating activity has been shown to drastically increase when large amounts of degradable organic substrates are available. The methylation of inorganic mercury is mostly attributed to sulfate-reducing bacteria (Compeau & Bartha, 1984, 1985; Gilmour and Henry, 1991; Gilmour et al., 1992; Choi and Bartha, 1993; Choi et al., 1994a,b; Parkman et al., 1994). These bacteria are also believed to be important agents of organic matter decomposition (Parkman et al., 1994). As decomposition and methylation are both microbial processes, their specific rates depend on the type, size and degree of activity of the microbial community (Cole & Heil, 1981; Staaf & Berg, 1981; Van Veen et al., 1981). Since microbial populations and their decomposing activities are increased after watershed disturbance (see sections I.2.1.3 and I.2.2.2), intensified methylation would be expected.

So far the sources of methylmercury in catchments (i.e., the methylation sites) have not been clearly identified (Branfireun, 1999). According to St. Louis et al. (1994b) and Branfireun et al. (1996), the contribution of *in situ* methylation processes to catchment methylmercury output is significant. Recent studies indicate that boreal catchments containing peatlands export considerably more methylmercury to drainage lakes than strictly upland catchments (St. Louis et al., 1994b, 1996). This occurs because wetlands in general act as an important source of methylmercury (St. Louis et al., 1994b, 1996; Bishop et al., 1995; Rudd, 1995; Hurley et al., 1995; Krabbenhoft et al., 1995; Branfireun et al., 1996). However, in catchments with limited wetlands, the importance

of other methylmercury sources in the watershed, such as the impacted soil, would markedly increase. Within the lakes selected for this study, wetlands account for at most 7% percent of the total area. According to calculations using a model presented by Branfireun (1999), in a catchment with 7% of its area covered by wetlands, the whole catchment yields three times as much methylmercury as its peatland area. In addition to the importance of the catchment (upland and wetland sites) as a methylmercury producer and exporter, mass balance calculations generally indicate that in-lake methylation is an important source of methylmercury as well (Fitzgerald and Watras, 1989; Watras et al., 1994). Therefore, methylmercury production from inorganic mercury may be increased as a result of the greater organic matter decomposition either along the catchment or in the lake, or most likely, in both.

4.3. Partitioning of methylmercury with DOC

The distribution ratio of chemical compounds between the particulate and dissolved phases is described by a partition coefficient, K_d .

$$K_d = \text{MeHg}_{\text{SPM}}(\text{pmole/g}) / \text{MeHg}_{\text{dissolved}}(\text{pmole/g}) \quad (\text{equation V.1}).$$

The partition coefficient has been shown to depend on the abundance and the organic carbon content of the SPM in the water column, on physicochemical characteristics of the sorbate molecules (methylmercury), on the concentration of sorbate in solution, on pH, and on the surface area of the sorbant (Allan, 1986; Andren et al., 1987).

Irrespective of whether or not methylmercury is produced and actively exported from the watershed following disturbance, increased lake concentrations may result from equilibrium partitioning between the particulate (i.e., SPM and sediments) and dissolved phases. In other words, an increase in DOC concentration would shift the equilibrium and draw methylmercury to the dissolved phase. Consequently, if this hypothesis is correct, methylmercury concentration in the SPM is expected to decrease.

In order to test the hypothesis of partitioning of methylmercury with the DOC, partition coefficients were calculated for the samples collected in September 1997, i.e., the ratio of the methylmercury concentration in the SPM (pmole/g dry weight) to the calculated dissolved methylmercury concentration (pmole/g) in the filtered water samples (Table IV.4). Results of this calculation are given in Table V.1.

Partition coefficient values usually decrease with increasing DOC concentrations in the water column (Elzerman and Coates, 1987). Unfortunately, data are only available for one lake of the logged group and six of the burnt group. Since logged-watershed lakes are underrepresented, it would be risky to compare these two groups. Moreover, the absence of values for the reference lakes does not allow a comparison between the impacted and the pristine states. Nevertheless, the average of the seven partition coefficient values available was calculated (3×10^4). Compared with partition coefficient data reported in the literature (Hurley et al., 1993; Mackay et al., 1995; Mucci et al., 1995), our average value is of the same order of magnitude. Given the paucity of measurements, it is impossible to discern an effect of the DOC concentration on the partition coefficient of methylmercury, and, thus, the hypothesis cannot be confirmed or disproved.

5. Total mercury in the sediments

In the logged group, the mean concentration of total mercury (0.10 nmole/g dw) is higher than in the burnt group (0.06 nmole/g dw) of lakes (Figure IV.9). Nevertheless, the mean concentration of total mercury in surficial bottom sediments is highest in the reference group of lakes (0.14 nmoles/g dry weight). Some studies indicate that large DOC concentrations in the water column inhibit the sedimentation of mercury (French et al., 1999). If this were the case, the residence time of mercury in the water column would be increased, as the partitioning of mercury with the water phase would be favored. This hypothesis satisfactorily explains why the mean total mercury concentration in the surficial bottom sediments is highest in the reference group of lakes, since in this group the mean DOC concentration in the water column is the lowest. Another acceptable explanation is the dilution of the total mercury. It was demonstrated that the SPM loading is higher in the logged and burnt groups of lakes in comparison to the reference groups. Since the SPM constitutes the ultimate source for the surficial bottom sediments, the sedimentation rates in the logged and burnt groups are expected to increase accordingly with the SPM loading. This larger availability of newly deposited sediments in the reference lakes would dilute the total mercury, i.e., its concentrations in the sediments would be lower relative to the logged and burnt groups of lakes.

Group mean C/N molar ratios of the sediments vary in practically the same manner as that of the C/N molar ratios of the SPM: logged > burnt \approx reference. This is perfectly expected, since, as mentioned above, the suspended material constitutes the ultimate source of the surficial bottom sediments. However, the mean C/N molar ratios in the sediments (19.4, logged; 17.3, burnt; 16.8, reference) are higher than those in the SPM (12.4, logged; 11.6, burnt; 11.7, reference). This is most likely a result of in-situ degradation of the organic material contained in the sediments. During diagenesis, nitrogen-rich compounds, such as proteinaceous material, are preferentially metabolized by micro-organisms. The nitrogen released with this process may be converted either to nitrate or ammonia, depending on the oxygen levels of the sediments. The ammonia, produced under anaerobic conditions, may diffuse towards the oxic zone, where it is nitrified to N_2 , or adsorbed onto clay and organic material. The nitrate, produced in oxygenated sediments, can also diffuse back to the water column, or else be used as an electron-acceptor for further oxidation of organic matter (Mucci, 1999, personal communication).

According to Warren and Zimmerman (1994), the cycle of deposition and resuspension produces a relatively uniform pool of particles next to the lake bottom, the nepheloid layer. Its long-term consequence is the accumulation of particle-associated contaminants on the least turbulent areas of the lake bottom. Given a plentiful supply of inorganic mercury to the sediments, methylmercury can be formed, where anaerobic (i.e., reducing to slightly sulphidic) methylation-favoring conditions are encountered, and remobilized back to the water column by diffusion or physical processes such as bioturbation and resuspension.

However, the variability in the total mercury concentrations in surficial bottom sediments (expressed as the standard error of the mean) is rather large (Figure IV.9). This indicates that the forest watershed perturbations are still too recent to have clearly affected the bottom sediments. For the sediments, the lag period between the disturbance and its effects will likely be longer than for the water column, in view of the typically low sedimentation rates (2-3 mm/year) in lakes of the Canadian Shield (Lucotte et al., 1995) and bioturbation at the lake bottom.

6. Chemical response delay

The time required for the full post-disturbance development of a chemical response in the soil solution and streamwater varies according to the chemical entity in question, the local conditions of the affected area, and the degree of disturbance (Kilgore, 1973; Jewett et al., 1995; Dahlgren and Driscoll, 1994). A lag period between the disturbance and its observed effects was attributed by Keenan and Kimmins (1993) to the slow decay of organic matter after the perturbation. According to Boormann and Likens (1979b), immediately after clear-cutting, when C/N molar ratios of the organic matter are high, dissolved soil nutrients are assimilated by the increasing microbial populations. As decomposition proceeds and the C/N molar ratios of the SPM decrease, the excess nutrient ions are leached from the soil into streamwater. For instance, the time lag for maximum nitrate leaching varies from 7 to 18 months (Sollins and McCorson, 1981; Clayton and Kennedy, 1985; Tiedemann et al., 1988; Dahlgren and Driscoll, 1994). In fact, Moore and Jackson (1989) and Moore (1989) have observed little effect of clear-cutting on DOC export immediately after clear-cutting, but a significant increase in runoff DOC concentrations 8 to 10 years after the disturbance. A significant increase in the SPM loading to the lakes is another expected effect after the lag period.

7. Lake and catchment morphometry

7.1. Correlations with methylmercury in the SPM

For the reference lakes, only three parameters are significant for the stepwise regression. These are lake area, lake perimeter, and lake volume. This emphasizes the strong correlation between the methylmercury concentrations in the SPM and the dimensions of the lakes. A possible explanation for this is that in the reference lakes direct atmospheric deposition on the lake surface (see section I.3.3) is a much more important source of methylmercury than the catchment export (see section I.3.4). In this case, lake water volume would be of importance in that it contains an inherent area component (refer to section II.2.1).

For the logged group of lakes, residence time and watershed area/lake area ratio stand out as the most important parameters (although they are not statistically significant). These two parameters are directly related with surface runoff. The watershed

area/lake area ratio in fact compares two potential sources of methylmercury: the terrestrial (i.e., from the catchment) contribution, and the direct atmospheric input (i.e., deposition on the lake surface). The larger the watershed area/lake area (WA/LA) ratio, the larger the terrestrial contribution of mercury and/or methylmercury would be in relation to direct atmospheric deposition. The fact that SPM methylmercury concentrations are proportional to the WA/LA ratio indicates that for the logged group of lakes the terrestrial source of methylmercury exceeds direct atmospheric deposition. The inverse relationship observed with lake water residence time emerges because lakes with relatively large catchment areas have short water residence times. This reflects the fact that large catchment areas contribute large amounts of water, which transit quickly through small lake basins.

When all lakes are included in the regression model, mean catchment slope is the only significant ($p < 0.05$) morphometric parameter. Catchment slope is related to surface runoff, which is responsible for the export of dissolved and particulate material to the lakes, especially DOC. D'Arcy and Carignan (1997), for instance, found a strong correlation between mean catchment slope and DOC. This suggests that the significant correlations found in this study between mean catchment slopes and SPM methylmercury concentrations may merely reflect the association between methylmercury and DOC.

7.2. Correlations with dissolved methylmercury

Drainage density is statistically significant towards the regression model both for the logged and the burnt groups of lakes. This indicates the importance of surface runoff in contributing methylmercury to lake water in those two treatment groups. Depth, both maximum and mean, is statistically significant ($p < 0.05$) for the reference lakes. Mean depth is also significant for the whole set of lakes. This probably reflects the fact that in deeper lakes the SPM has a longer residence time, i.e., it stays longer in the water column before being incorporated into the sediments. Therefore the methylmercury associated with the SPM remains longer in the water column of deeper lakes. This is supported by the fact that water residence time ($r=0.376$), mean depth ($r=0.576$), and maximum depth ($r=0.483$) all show a similar relationship (Pearson's correlation coefficient) with dissolved methylmercury in the water column.

In the burnt and reference groups, as well as for the whole set of lakes, littoral slope contributes significantly ($p < 0.05$) to the regression model, probably by favoring resuspension. The importance of resuspension to the remobilization of methylmercury from sediments and pore-waters to the overlying waters has been indicated by Mucci et al. (1995).

7.3. Total mercury in the sediments

For the logged group of lakes, the significance of the watershed area/ lake area ratio reflects the importance of the terrestrial source over the direct atmospheric deposition of mercury.

For the burnt group of lakes, the following morphometric parameters, given in order of decreasing significance (increasing p-value), yielded statistically significant correlations: watershed area, catchment area, catchment stream length, water flow, catchment perimeter, sum of wetland areas, and altitude. The first five are directly related to the catchment, once again emphasizing the importance of surface runoff as a source of mercury to these lakes.

For the reference lakes, the fact that lake dimensions (area, perimeter, volume, depth) and water residence time are not significantly correlated with total mercury concentrations could mean that, if direct atmospheric deposition has any importance for these lakes, it is not reflected on the sediments.

8. Lake water chemistry

Meili (1991c) and Parkman and Meili (1993) reported mercury concentrations in the biota that are proportional to those in the water. For our study lakes, mean methylmercury contents in the zooplankton were found to be significantly higher in the logged relative to the burnt and reference groups by Garcia and Carignan (1999). Increased concentrations of methylmercury in the zooplankton after clear-cutting were also observed by Rask et al. (1994) in a small humic lake. Zooplankton is a good indicator of methylmercury contamination because it directly ingests allochthonous organic carbon and can readily assimilate bioavailable methylmercury from the water column (Hessen et al., 1990; Garcia and Carignan, 1999). Similarly to zooplankton

(Garcia and Carignan, 1999), methylmercury accumulation in fish has also been correlated with DOC or water color (McMurtry et al., 1989).

Garcia and Carignan (1999) correlated the higher mean concentrations of zooplankton methylmercury and water DOC in the logged group of lakes with the lower mean water pH. However, their observed among-group differences in pH were not significant ($p > 0.05$) and covered a small range (mean values of 6.6, 6.5, and 6.7, in the burnt, logged, and reference groups of lakes, respectively). Other authors also reported a negative correlation between pH and methylmercury concentrations in zooplankton (Watras and Bloom, 1992; Westcott and Kalff, 1996). In fish, even very small decreases in pH result in increased mercury accumulation rates (Ponce and Bloom, 1991). According to Winfrey and Rudd (1990), pH affects the dissociation of mercury, the relative rates of methylation and demethylation, and the physiology of the organisms.

pH is widely recognized as a key variable in determining the extent of sorption of contaminants onto the particulate phase (Warren and Zimmerman, 1994). An increase in the pH of natural systems usually favors removal by adsorption of trace elements from solution (Langmuir, 1997). According to Reimers and Krenkel (1974), changes in mercury solubility with pH are due to changes in organic matter solubility rather than to desorption of mercury to the solution. Likewise, Andersson (1979) report that mercury-organic adsorption curves show no response to pH, whereas adsorption by clays and oxides is strongly pH-dependent. However, the sorptive potential of solid phases such as clays is not as great as that of humic substances (Rashid, 1985), in spite of their highly negative surface charges and small particle sizes, often below 1 μm (Langmuir, 1997).

In the present study, group mean pH values were not statistically different ($p > 0.05$). Mean hydrogen ion (H^+) concentrations and pH values, respectively, in September 1997 were: 0.54 $\mu\text{eq/l}$ and 6.6 in the burnt group, 0.79 $\mu\text{eq/l}$ and 6.2 in the logged group, and 0.74 $\mu\text{eq/l}$ and 6.2 in the reference group. In May 1998, mean H^+ concentrations and pH values were, respectively: 0.60 $\mu\text{eq/l}$ and 6.3 in the burnt group, 0.71 $\mu\text{eq/l}$ and 6.2 in the logged group, and 0.77 $\mu\text{eq/l}$ and 6.2 in the reference group of lakes.

It should be noted from the Pearson's determination coefficients (Table IV.15) that the water dissolved methylmercury concentrations do not significantly correlate with

DOC or any other lake water chemical parameter This suggests that the chemical mechanisms associated with methylmercury mobilization in the water column are highly variable or are dependent on another chemical factor not included in the analyses. One such factor could be the particulate organic carbon (POC) concentrations in the water column. According to the model proposed by Thérien and Morrison (1986), particulate and dissolved organic matter are simultaneously released from the original (or total) organic material. Results reported by Kolka et al. (1999), indicate that POC may be more important than DOC as a mobilization and transport vector of mercury, depending on the properties of the watershed, especially peatland and upland areas. If this is correct, the dissolved methylmercury concentrations observed in this study would be expected to correlate significantly with the POC levels in the water column. This would also explain why the correlation between dissolved methylmercury and DOC is not significant, by considering that the characteristics of the watersheds under study favor the association of mercury with the POC to a larger extent than with the DOC.

VI – SUMMARY AND CONCLUSIONS

Over the past few years, an increasing number of reports have been issued about mercury contamination in remote lakes. Although it is a recent finding that the biota in these remote lakes can accumulate deleterious concentrations of mercury, the sources and pathways of this contamination, specifically involving atmospheric deposition, were readily identified (see section I.3). Nevertheless, knowledge is still lacking as to how the terrestrial loading of mercury and methylmercury to drainage lakes can be affected by deforestation of the adjacent watershed, either anthropogenically through clear-cutting, or through natural and recurring forest fires.

The concept of forest disturbance has long been recognized by ecology and forestry professionals (Oliver and Larson, 1990). Concerns over its long-term effects on soil nutrient reserves have been expressed for at least 40 years (Rennie, 1955; Ovington, 1962). However, it was only during the last two decades that the importance of forest disturbance was recognized and the issue became intensively studied and discussed (Oliver and Larson, 1990; Attiwil, 1994a). The main conclusion of these studies was that disturbance controls the development of most world forests, by affecting their diversity, structure, and function (Oliver and Larson, 1990; Attiwil, 1994a). Today natural disturbance is increasingly recognized as a dominant force in the forest ecosystem (Attiwil, 1994b). Nevertheless, the impact of forest perturbations on long-term site productivity has not yet been revealed (Powers et al., 1990).

An attempt has been made here to determine the differential effects of forest fires and clear-cutting on lake water chemistry, with emphasis on particulate (SPM-associated) and dissolved methylmercury concentrations, and surficial bottom sediment total mercury concentrations. Three groups of lakes were selected and systematically visited for sample collection and environmental data gathering. The three groups of lakes were carefully chosen to minimize differences in morphometry and assumed hydrology. One group comprised nine lakes whose watershed forest naturally and spontaneously burnt in 1995. The second group consisted of another nine lakes whose adjacent watershed forest was partially or completely removed (clear-cut) by logging companies in 1995. Some of these lakes were additionally logged in 1998. Finally, the control group consisted of 20 lakes whose watersheds were not touched by forest fires or logging for at least 70 years. These

20 reference lakes reflect the natural state of lake mercury and methylmercury levels in the study area, free from the modifications inflicted by watershed forest perturbations. Prior to the last sampling campaign (May 1998), four reference lakes had varying percentages of their forested catchment clear-cut by logging companies. The objective was to measure the impact of clear-cutting on lake water chemistry (methylmercury concentrations) shortly (less than one year) after the disturbance.

Regardless of all possible sources of variability, which may reduce the consistency and clarity of results, and of all the unexpected limitations to the experimental and analytical design, some general conclusions can be expressed, as follows.

In comparison to forest fires, clear-cutting produces a much larger amount of on-site residual organic matter. Following watershed disturbance, the residual organic material is progressively decomposed and partly exported with the intensified surface runoff. The intensification of surface runoff is greater in clear-cut than in burnt watersheds because clear-cutting, in addition to completely removing the forest and leaving no surface obstacle to restrain the water flow, may mechanically compact the soil, reducing its porosity and water permeability. Therefore, with greater surface runoff in the clear-cut catchments, the amount of particles exported is also greater than in the burnt catchments. The fact that the difference in suspended particulate matter (SPM) concentrations in the three treatment groups of lakes is not statistically significant (95% confidence level) may indicate that the impact of the perturbations has not yet been fully recorded in the short period of time elapsed since the perturbations.

Due to their nature and composition, the degradation of residues from the burnt catchments is easier and faster in comparison to the logged catchments. The organic residue of the clear-cut areas is denser, richer in refractory substances (e.g., lignin) and has high C/N ratios, which leads to slower degradation as well as to nitrogen immobilization. The latter mechanism is important in the logged catchments, where it restricts leaching losses of nitrogen, leading to a progressive decrease in the C/N molar ratios of the organic matter. Nitrogen immobilization thus accounts for the lower concentrations of total nitrogen, nitrate and ammonium in the water column of the logged

group of lakes, in contrast to those with burnt catchments, where little or no nitrogen immobilization takes place and nitrogen is continuously released.

Although the degradation of organic residue is hindered in the logged catchments, the availability of organic matter and the surface runoff are greater than in the burnt catchments. The result is a larger terrestrial input of dissolved organic carbon (DOC) to the logged than to the burnt group of lakes, as seen from the statistically significant (95% confidence level) higher DOC concentrations in the former group of lakes. As DOC is predominantly generated from the degradation of particulate organic carbon (POC), which is slower in the logged catchments as compared to the burnt ones, the terrestrial input of POC is also expected to be significantly larger to lakes of the logged than to those of the burnt group. Therefore, logged watersheds export much larger amounts of organic matter (DOC and POC) to lakes in comparison to the burnt and pristine (reference) states.

The higher export of organic carbon from the logged watersheds, is believed to be responsible for the delivery and maintenance of significantly (95% confidence level) higher concentrations of dissolved methylmercury and, presumably, inorganic mercury in the logged group of lakes comparatively to the two other treatment groups. This conclusion is based on the hypothesis that both dissolved (DOC) and particulate organic carbon (POC) serve as strong and limiting vectors (as seen from their intimate association) of mercury and methylmercury to the lake waters (Jackson, 1988, 1991; Verta et al., 1989; Johansson et al., 1991; Lee and Iverfeldt, 1991; Meili et al., 1991; Mierle and Ingram, 1991; Driscoll et al., 1994, 1995; Hurley et al., 1995; Hintelmann et al., 1995; Kolka et al., 1999).

The significant correlation between morphometric parameters of the catchment and methylmercury concentrations in the water column of the logged and burnt groups of lakes reflects the importance of the terrestrial sources of mercury and/ or methylmercury following watershed disturbance. These correlations can be interpreted to indicate that watershed forest disturbance promotes the remobilization of mercury species from the catchment and elevate their concentrations in the lake water column. Biological uptake, as well as particle settling and resuspension, may regulate the maximum water column

load of methylmercury, with the sediments and the biota acting as contamination buffers, releasing or absorbing methylmercury.

In summary, watershed deforestation disturbances increase the catchment export of DOC, SPM, and methylmercury to drainage lakes. Comparing the two types of watershed disturbance investigated, this impact is stronger as a result of clear-cutting than of forest fire.

BIBLIOGRAPHY

- Aastrup, M.; Johnson, J.; Bringmark, E.; Bringmark, H.; Iverfeldt, A. 1991. Occurrence and transport of mercury within a small catchment area. *Water, Air, Soil Pollut.* 56: 155-167.
- Adams, P.W.; Boyle, J.R. 1982. Soil fertility changes following clearcut and whole-tree harvesting and burning in central Michigan. *Soil Sci. Soc. Am. J.* 46: 638-640.
- Alexander, M. 1977. *Introduction to Soil Microbiology*. 2nd ed. John Wiley & Sons, New York, NY. 467 p.
- Allan, R.J. 1986. The role of particulate matter in the fate of contaminants in aquatic ecosystems. Scientific Series, No. 142. Inland Waters Directorate, National Water Research Institute, Canada Centre for Inland Waters, Burlington, ON.
- Andersson, A. 1979. Mercury in soils. In: O. Nriagu (ed.) *The Biogeochemistry of Mercury in the Environment*. Elsevier/North Holland Biomedical Press, Amsterdam pp. p. 79-122.
- Andren, A.W.; Doucette, W.J.; Dickhut, R.M. 1987. Method for estimating solubilities of hydrophobic organic compounds: environmental modeling efforts. In: R. Hites and S.J. Eisenreich (eds.). *Sources and Fates of Aquatic Pollutants*. Advanced Chemistry Series No. 216. American Chemical Society, Washington, D.C. 558 p. pp. 14-19.
- Armstrong, G.W. 1998. A stochastic characterization of the natural disturbance regime of Alberta's boreal forest: a simple process producing complex outcomes. Sustainable Forest Management Network of Centers of Excellence. Working Paper SES-3. 18 pp.
- Ash, A. 1995. Effects of clear-cutting on litter parameters in the Southern Blue Ridge Mountains. *Castanea* 60: 89-97.
- Ashwort, W. 1991. *The Encyclopedia of Environmental Studies*. Facts on File Inc., New York, NY. 470 p. pp. 47, 112, 355.
- Atlas Climatologique du Québec. 1978. Ministère des Richesses Naturelles. Direction Générale des Eaux, Québec, QC. 42 p.
- Attiwill, P.M. 1994a. The disturbance of forest ecosystems: the ecological basis for conservative management. *For. Ecol. Manag.* 63: 247-300.
- Attiwill, P.M. 1994b. Ecological disturbance and the conservative management of eucalypt forests in Australia. *For. Ecol. Manag.* 63: 301-346.
- Barnett, M.O.; Harris, L.A.; Turner, R.R.; Henson, T.J.; Melton, R.E.; Stevenson, R.J. 1995. Characterization of mercury species in contaminated floodplain soils. *Water, Air, Soil Pollut.* 80: 1105-1108.
- Beasley, R.S.; Granillo, A.B.; Silmer, V. 1986. Sediment losses from forest management: mechanical versus chemical site preparation after clear-cutting. *J. Environ. Qual.* 15: 413-

- Benes, R.; Gjessing, E.T.; Steinnes, E. 1976. Interaction between humus and trace elements in fresh water. *Water Res.* 10: 711-716.
- Berdén, M.; Nilsson, S.I.; Nyman, P. 1997. Ion leaching before and after clear-cutting in a Norway spruce stand – Effects of long-term application of ammonium nitrate and superphosphate. *Water, Air, Soil Pollut.* 93: 1-26.
- Berg, B.; Staaf, H. 1981. Leaching, accumulation and release of nitrogen in decomposing forest litter. In: F.E. Clark and T. Rosswall (eds.). *Terrestrial Nitrogen Cycles*. *Ecol. Bull.* (Stockholm) 33: 163-178.
- Bergeron, Y. 1991. The influence of inland and mainland lakeshore landscapes on boreal forest fire regimes. *Ecol.* 72: 1980-1992.
- Bergeron, Y.; Harvey, B.; Leduc, A. 1998a. Natural fire regime: a guide for sustainable forest management of the boreal forest. Sustainable Forest Management Network of Centers of Excellence. Working Paper EBS-1. 4 pp.
- Bergeron, Y.; Harvey, B.; Leduc, A.; Gauthier, S. 1998b. Silvicultural practices and forest management strategies that emulate natural disturbances. Sustainable Forest Management Network of Centers of Excellence. Working Paper 1998-6. 12 pp.
- Berman, M.; Bartha, R. 1986. Levels of chemical versus biological methylation of mercury in sediments. *Bull. Environ. Contam. Toxicol.* 36: 401-404.
- Binkley, D.; Richter, D. 1987. Nutrient cycling and H⁺ budgets of forest ecosystems. *Adv. Ecol. Res.* 16: 1-51.
- Bishop, K.; Lee, Y.H.; Petterson, C.; Allard, B. 1995. Terrestrial sources of methylmercury in surface waters: the importance of the riparian zone on the Svartberg catchment. *Water, Air, Soil Pollut.* 80: 435-444.
- Bloom, N.S. 1989. Determination of picogram levels of methylmercury by aqueous phase ethylation, followed by cryogenic gas chromatography with cold vapor atomic fluorescence detection. *Can. J. Fish. Aquat. Sci.* 46: 1131-1140.
- Bloom, N.S. 1992. On the chemical form of mercury in edible fish and marine invertebrate tissue. *Can. J. Fish. Aquat. Sci.* 49: 1010-1017.
- Bloom, N.S.; Crecelius, E.A. 1983. Determination of mercury in seawater at sub-nanogram per liter levels. *Mar. Chem.* 14: 49-59.
- Bloom, N.S.; Fitzgerald, W.F. 1988. Determination of volatile mercury species at the picogram level by low temperature gas chromatography with cold vapor atomic fluorescence detection. *Anal. Chim. Acta.* 208: 151-161.

- Bloom, N.S.; Watras, C.J. 1989. Observations of methylmercury in precipitation. *Sci. Total Environ.* 87/88: 199-207.
- Bloom, N.S.; Effler, S.W. 1990. Seasonal variability in the mercury speciation of Onondaga Lake (New York). *Water, Air, Soil Pollut.* 53: 251-265.
- Bloom, N.S.; Horvat, M.; Watras, C.J. 1995. Results of the international aqueous speciation intercomparison exercise. *Water, Air, Soil Pollut.* 80: 1257-1268.
- Bloom, N.S.; Vondergeest, E.J. 1995. Matrix modification to improve the recovery of MMHg from clear water using distillation. *Water, Air, Soil Pollut.* 80: 1319-1323.
- Bockheim, J.G.; Ballard, T.M.; Willington, R.P. 1975. Soil disturbance associated with timber harvesting in southwestern British Columbia. *Can. J. For. Res.* 5: 285-290.
- Bodaly, R.A.; Rudd, J.W.M.; Fudge, R.J.P.; Kelly, C.A. 1993. Mercury concentrations in fish related to size of remote Canadian Shield lakes. *Can. J. Fish. Aquat. Sci.* 50: 980-987.
- Bonan, G.B.; Shugart, H.H. 1989. Environmental factors and ecological processes in boreal forests. *Ann. Rev. Ecol. Syst.* 20: 1-28.
- Bono, A.B. 1997. The partitioning of mercury among the solid components of sediments of the Saguenay Fjord, Québec. Master's Thesis. McGill University, Montreal, QC. 177 p.
- Boormann, F.H.; Likens, G.E. 1979a. Catastrophic disturbance and the steady state in northern hardwood forests. *Am. Sci.* 67: 660-669.
- Boormann, F.H.; Likens, G.E. 1979b. Pattern and Process in a Forested Ecosystem: Disturbance, Development and the Steady State Based on the Hubbard Brook Ecosystem Study. Springer-Verlag. New York, NY. 253 pp.
- Boudou, A.; Ribeyre, F. 1981. Comparative study of the trophic transfer of two mercury compounds, $HgCl_2$ and CH_3HgCl , between *Chlorella vulgaris* and *Daphnia magna*. Influence of temperature. *Water, Air, Soil Pollut.* 26: 137-148.
- Brady, N.C. 1984. *The Nature and Properties of Soils*. 9th ed. Macmillan Publishing Company, New York, NY.
- Brais, S.; Camiré, C.; Paré, D. 1995. Impacts of whole-tree harvesting and winter windrowing on soil pH and base status of clayey sites of northwestern Quebec. *Can. J. For. Res.* 25: 997-1007.
- Branfireun, B.A. 1999. Catchment-scale hydrology and methylmercury biogeochemistry in the low boreal forest zone of the Precambrian Shield. Ph.D. Thesis. McGill University, Montreal, QC. 113 p.
- Branfireun, B.A.; Heyes, A.; Roulet, N.T. 1996. The hydrology and methylmercury dynamics of a Precambrian Shield headwater peatland. *Water Resour. Res.* 32(6): 1785-1794.

- Brosset, C. 1981. The mercury cycle. *Water, Air, Soil Pollut.* 16: 253-255.
- Brosset, C. 1982. Total airborne mercury and its possible origin. *Water, Air, Soil Pollut.* 17: 37-50.
- Brosset, C. 1983. Transport of airborne mercury emitted by coal burning into aquatic systems. *Water Sci. Technol.* 15: 59-66.
- Brown, G.W.; Gahler, A.R.; Marston, R.B. 1973. Nutrient losses after clear-cut logging and slash burning in the Oregon Coast Range. *Water Resour. Res.* 9: 1450-1453.
- Brumelis, G.; Carleton, T.J. 1988. The vegetation of postlogged black spruce lowlands in Central Canada. I. Trees and tall shrubs. *Can. J. For. Res.* 18: 1470-1478.
- Buringh, P. 1984. The organic carbon in soils of the world. In: G.M. Woodwell (ed.). *The Role of Terrestrial Vegetation in the Global Carbon Cycle: Measurement by Remote Sensing.* John Wiley and Sons, Chichester, UK. 247 p. pp. 91-109.
- CRFQ – Conseil de la Recherche Forestière au Québec. 1995. *Le secteur forestier québécois face à ses défis: des orientations de recherche et de développement.* 47 pp.
- Carignan, R.; D'Arcy, P.; Pinel-Alloul, B.; Kalff, J.; Planas, D.; Magnan, P. 1999. Comparative impacts of fire and forest harvesting on water quality in boreal shield lakes. In: T.S. Veeman; D.W. Smith; B.G. Salkie; G.A. Larkin (eds.). *Science & Practice: Sustaining the Boreal Forest. Proceedings 1999 Sustainable Forest Management Network Conference,* Edmonton, AB. pp. 121-126.
- Carleton, T.J.; MacLellan, P. 1994. Woody vegetation responses to fire versus clear-cutting logging: a comparative survey in the central Canadian boreal forest. *Ecosci.* 1: 141-152.
- Cerri, C.C.; Volkoff, B.; Andreux, F. 1991. Nature and behavior of organic matter in soils under natural forest, and after deforestation, burning, and cultivation, near Manaus. *For. Ecol. Manag.* 38: 247-257.
- Chaire de recherche en environnement. 1993. Sources et devenir du mercure dans les réservoirs hydro-électriques. *Rapport annuel 1992-1993.* Chaire de recherche en environnement Hydro-Québec/ CRSNG/ UQAM, Montreal, QC.
- Chaney, R.L. 1973. Crop and food-chain effects of toxic elements in sludges and effluents on land. In: *Recycling Municipal Sludges and Effluents on Land.* US-EPA, Washington, D.C. pp. 129-144.
- Chen, C.W.; Gherini, S.A.; Peters, N.E.; Murdoch, P.S.; Newton, R.M.; Goldstein, R.A. 1984. Hydrologic analysis of acidic and alkaline lakes. *Water Resour. Res.* 16: 1875-1882.
- Choi, S.C.; Bartha, R. 1993. Cobalamin-mediated mercury methylation by *Desulfovibrio desulfuricans* LS. *Appl. Environ. Microbiol.* 59: 290-295.

- Choi, S.C.; Bartha, R. 1994. Environmental factors affecting mercury methylation in estuarine sediments. *Bull. Environ. Contam. Toxicol.* 53: 805-812.
- Choi, S.C.; Chase, T.; Bartha, R. 1994a. Enzymatic catalysis of mercury methylation by *Desulfovibrio desulfuricans* LS. *Appl. Environ. Microbiol.* 60: 1342-1346.
- Choi, S.C.; Chase, T.; Bartha, R. 1994b. Metabolic pathways leading to mercury methylation in *Desulfovibrio desulfuricans* LS. *Appl. Environ. Microbiol.* 60: 4072-4077.
- Chu, P.; Porcella, D.B. 1995. Mercury stack emissions from US electric utility power plants. *Water, Air, Soil Pollut.* 80: 135-144.
- Clair, T.A.; Freedman, B. 1986. Patterns and importance of dissolved organic carbon in four acidic brownwater streams in Nova Scotia, Canada. *Water, Air, Soil Pollut.* 31: 139-147.
- Clayton, J.S.; Ehrlich, W.A.; Cann, D.B.; Day, J.H.; Marshall, I.B. 1978. *Soils of Canada*. Department of Agriculture, Ottawa, ON. 2 vol.
- Clayton, J.L.; Kennedy, D.A. 1985. Nutrient losses from timber harvest in the Idaho batholith. *Soil Sci. Soc. Am. J.* 49: 1041-1049.
- Cole, D.W. 1981. Nitrogen uptake and translocation by forest ecosystems. In: F.E. Clark and T. Rosswall (eds.). *Terrestrial Nitrogen Cycles*. *Ecol. Bull. (Stockholm)* 33: 219-232.
- Cole, C.V.; Heil, R.D. 1981. Phosphorus effects on terrestrial nitrogen cycling. In: F.E. Clark and T. Rosswall (eds.). *Terrestrial Nitrogen Cycles*. *Ecol. Bull. (Stockholm)* 33: 163-178.
- Compeau, G.; Bartha, R. 1983. Effects of sea salt anions on the formation and stability of methylmercury. *Bull. Environ. Contam. Toxicol.* 31: 486-493.
- Compeau, G.; Bartha, R. 1984. Methylation and demethylation of mercury under controlled redox, pH, and salinity conditions. *Appl. Environ. Microbiol.* 48: 1203-1207.
- Compeau, G.; Bartha, R. 1985. Sulfate-reducing bacteria: principal methylators of mercury in anoxic estuarine sediment. *Appl. Environ. Microbiol.* 50: 498-502.
- Cossa, D. 1990. Biogéochimie. In: Cossa, D.; Thibaud, Y.; Romeo, M.; Gnassia-Barelli, M. *Le Mercure en Milieu Marin: Biogéochimie et Ecotoxicologie*. 130 p. pp. 11-51.
- Covington, W.W. 1981. Changes in forest floor organic matter and nutrient content following cutting in northern hardwoods. *Ecol.* 62: 41-48.
- Cronan, C.S.; Aiken, G.R. 1985. Chemistry and transport of soluble humic substances in forested watersheds of the Adirondack Park, New York. *Geochim. Cosmochim. Acta* 49: 1697-1705.
- Curtis, P.J.; Schindler, D.W. 1997. Hydrologic control of dissolved organic matter in low-order Precambrian Shield lakes. *Biogeochem.* 36: 125-138.
- Dahlgren, R.A.; Driscoll, C.T. 1994. The effects of whole-tree clear-cutting on soil processes at

- the Hubbard Brook Experimental Forest, New Hampshire, USA. *Plant and Soil* 158: 239-262.
- Dansereau, P.R.; Bergeron, Y. 1991. Fire history in the Southern boreal forest of northwestern Quebec. *Can. J. For. Res.* 23: 25-32.
- D'Arcy, P.; Carignan, R. 1997. Influence of catchment topography on water chemistry in southeastern Québec Shield lakes. *Can. J. Fish. Aquat. Sci.* 54: 2215-2227.
- Darnall, D.W.; Greene, B.; Henzl, M.T.; Hosea, J.M.; McPherson, R.A.; Sneddon, J.; Alexander, M.D. 1986. Selective recovery of gold and other metal ions from an algal biomass. *Environ. Sci. Technol.* 20: 206-208.
- De Kimpe, C.R.; Bourbeau, G.A.; Baril, R.W. 1980. Pedological aspects of till deposits in the province of Quebec. In: R.F. Legget (ed.). *Glacial till: an inter-disciplinary study*. R. Soc. Can. Spec. Publ. No. 12. pp. 156-168.
- Dmytriw, R.; Mucci, A.; Lucotte, M.; Pichet, P. 1995. The partitioning of mercury in the solid components of dry and flooded forest soils and sediments from a hydroelectric reservoir, QC. *Water, Air, Soil Pollut.* 80: 1099-1103.
- Driscoll, C.T.; Yen, C.; Schofield, C.L.; Munson, R.; Holsapple, J. 1994. The chemistry and bioavailability of mercury in remote Adirondack lakes. *Environ. Sci. Technol.* 28: 136A-143A.
- Driscoll, C.T.; Blette, V.; Yan, C.; Schofield, C.L.; Munson, R.; Holsapple, J. 1995. The role of dissolved carbon in the chemistry and bioavailability of mercury in remote Adirondack lakes. *Air, Water, Soil Pollut.* 80: 499-508.
- Dudas, J.J.; Pawluk, S. 1976. The nature of mercury in chemozonic and luvisolic soils in Alberta. *Can. J. Soil. Sci.* 56: 413-423.
- Dymess, C.T. 1967. Erodability and erosion potential of forest watersheds. In: W.E. Sopper and H.W. Lull (eds.). *International Symposium on Forest Hydrology*. Pergamon Press, Elmsford, N.Y. 813 p. pp. 599-611.
- Eckhardt, B.W.; Moore, T.R. 1990. Controls on dissolved organic carbon concentrations in streams, southern Quebec. *Can. J. Fish. Aquat. Sci.* 47: 1537-1544.
- Elzerman, A.W.; Coates, J.T. 1987. Hydrophobic organic compounds on sediments: equilibria and kinetics of sorption. In: R.A. Hites and S.J. Eisenreich (eds.). *Sources and Fates of Aquatic Pollutants*. Advances in Chemistry Series. No. 216. American Chemical Society, Washington, D.C. 588 p. pp. 263-317.
- Emteborg, H.; Björklund, E.; Ödman, F.; Karlsson, L.; Mathiasson, L.; Frech, W.; Baxter, D.C. 1996. Determination of methylmercury in sediments using supercritical fluid extraction and

- gas chromatography coupled with microwave-induced plasma atomic emission spectrometry. *Analyst* 121: 19-29.
- Engelmark, O.; Bradshaw, R.; Bergeron, Y. 1993. *Disturbance Dynamics in Boreal Forest*. Opulus Press, Uppsala, Sweden. 104 p.
- Environment Canada. 1992. *Sommaire chronologique de l'écoulement: Québec*. Direction Générale des Eaux Intérieures. Environment Canada, Hull, QC.
- Evans, R.D. 1986. Sources of mercury contamination in the sediments of small headwater lakes in south-central Ontario, Canada. *Arch. Environ. Sci. Technol.* 23: 1047-1056.
- Fang, S.C. 1978. Sorption and transformation of mercury vapor by dry soil. *Environ. Sci. Technol.* 12: 285-288.
- Federer, C.A.; Hornbeck, J.W.; Tritton, L.M.; Martin, C.W.; Pierce, R.S.; Smith, C.T. 1989. Long-term depletion of calcium and other nutrients in eastern US forests. *Environ. Manage.* 13: 593-601.
- Fellenberg, G. 1980. *Introdução aos Problemas da Poluição Ambiental*. Editora Pedagógica e Univeritária Ltda., São Paulo, Brazil. 196 p. pp. 89-92.
- Feller, M.C. 1982. The ecological effects of slash burning. *Land Manage. Rep.* 13. B.C. Ministry of Forests, Victoria, B.C.
- Feller, M.C.; Kimmins, J.P. 1984. Effects of clear-cutting and slash burning on streamwater chemistry and watershed nutrient budgets in southwestern British Columbia. *Water Resour. Res.* 20: 29- 40.
- Fitzgerald, W.F.; Watras, C.J. 1989. Mercury in the surficial waters of rural Wisconsin lakes. *Sci. Total Environ.* 87/88: 223-228.
- Flaig, W.; Beutelspacher, H.; Rietz, E. 1975. Chemical composition and physical properties of humic substances. In: J.E. Gieseking. *Soil Components*. Vol. 1. Organic Components. Springer-Verlag, New York, NY.
- Flinn, M.A.; Wein, R.W. 1977. Depth of underground plant organs and theoretical survival during fire. *Can. J. Bot.* 55: 2550-2554.
- Foster, D.R. 1983. The history and patterns of fire in the boreal forest of Southeastern Labrador. *Can. J. Bot.* 61: 2459-2471.
- Foster, D.R. 1985. Vegetation development following fire in *Picea mariana* (black spruce) – Pleurozium forests of Southeastern Labrador, Canada. *J. Ecol.* 73: 517-534.
- Freedman, B.; Clair, T.A. 1987. Ion mass balances and seasonal fluxes from four acidic brownwater streams in Nova Scotia. *Can. J. Fish. Aquat. Sci.* 44: 538-548.
- French, K.J.; Scruton, D.A.; Anderson, M.R.; Schneider, D.C. 1999. Influence of physical and

- chemical characteristics on mercury in aquatic sediments. *Water, Air, Soil Pollut.* 110: 347-362.
- Friedriksen, R.L. 1971. Comparative chemical water quality – Natural and disturbed streams following logging and slash burning. In: J.T. Krygier and J.D. Hall (eds.). *Forest Land Uses and Stream Environment*. Oregon State University, Corvallis, OR.
- Friske, P.W.B.; Coker, W.B. 1995. The importance of geological controls on the natural distribution of mercury in lake and stream sediments across Canada. *Water, Air, Soil Pollut.* 80: 1047-1051.
- Froelich, H.A. 1988. Causes and effects of soil degradation due to timber harvesting. In: J.D. Lousier and G.W. Still (eds.) *Degradation of Forested Land: Forest Soils at Risk*. Land Manage. Rep. 56. B.C. Ministry of Forests, Victoria, BC.
- Fuller, R.D.; Simone, D.M.; Driscoll, C.T. 1988. Forest clear-cutting effects on trace metal concentrations: spatial patterns in soil solutions and streams. *Water, Air, Soil Pollut.* 40: 185-195.
- Gagnon, C.; Pelletier, E.; Mucci, A.; Fitzgerald, W.F. 1996. Diagenetic behavior of methylmercury in organic-rich coastal sediments. *Limnol. Oceanogr.* 41: 428-434.
- Garcia, E.; Carignan, R. 1999. Impact of wildfire and clear-cutting in the boreal forest on methylmercury in zooplankton. *Can. J. Fish. Aquat. Sci.* 56: 339-345.
- Gaudet, C.; Lingard, S.; Cureton, P.; Keenleyside, K.; Smith, S.; Raju, G. 1995. Canadian environmental quality guidelines for mercury. *Water, Air, Soil Pollut.* 80: 1149-1159.
- Gill, G.A.; Fitzgerald, W.F. 1987. Picomolar mercury measurements in seawater and other materials using stannous chloride reduction and two-stage gold amalgamation with gas phase detection. *Mar. Chem.* 20: 227-243.
- Gilmour, C.C.; Henry, C.A. 1991. Mercury methylation in aquatic systems affected by acid deposition. *Environ. Pollut.* 71: 131-169.
- Gilmour, C.C.; Henry, C.A.; Mitchell, R. 1992. Sulfate stimulation of mercury methylation in freshwater sediments. *Environ. Sci. Technol.* 26: 2281-2287.
- Gilmour, C.G.; Bloom, N.S. 1995. A case study of mercury and methylmercury dynamics in a mercury-contaminated municipal wastewater treatment plant. *Water, Air, Soil Pollut.* 80: 799-803.
- Glass, G.E.; Leonard, E.N.; Chan, W.H.; Orr, D.B. 1986. Airborne mercury in precipitation in the Lake Superior region. *J. Great Lakes Res.* 12: 37-51.
- Gobeil, C.; Cossa, D. 1984. Profils des teneurs en mercure dans les sédiments et les eaux interstitielles du fjord du Saguenay (Québec): données acquises au cours de la période 1978-

83. Rapp. Tech. Can. Hydrogr. Sci. Ocean. No. 53. 23 p.
- Granhall, U. 1981. Biological nitrogen fixation in relation to environmental factors and functioning of natural ecosystems. In: F.E. Clark and T. Rosswall (eds.). Terrestrial Nitrogen Cycles. Ecol. Bull. (Stockholm) 33: 131-144.
- Greacen, E.L.; Sands, R. 1980. Compaction of forest soils. A review. Aust. J. Soil Res. 18: 163-189.
- Grondin, A.; Lucotte, M.; Mucci, A.; Fortin, B. 1995. Mercury and lead profiles and burdens in soils of Quebec (Canada) before and after flooding. Can. J. Fish. Aquat. Sci. 52: 2493-2506.
- Groot, A. 1987. Silvicultural consequences of forest harvesting on peatlands: site damage and slash conditions. Information Report O-X-384. Canadian Forestry Service, Great Lakes Forestry Service.
- Hara, T.J.; Law, Y.M.C.; MacDonald, S. 1976. Effects of mercury and copper on the olfactory response in rainbow trout, *Salmo gairdneri*. J. Fish. Res. Board. Can. 33: 1568-1573.
- Haraldsson, C.; Westerlund, S.; Ohman, P. 1989. Determination of mercury in natural samples at the sub-nanogram level using inductively coupled plasma/ mass spectrometry after reduction to elemental mercury. Anal. Chim. Acta 221: 77-84.
- Heinselman, M.L. 1973. Fire in the virgin forests of the Boundary Waters Canoe Area, Minnesota. Quat. Res. 3: 329-382.
- Hempel, M.; Wilken, R.D.; Miess, R.; Hertwich, J.; Beyer, K. 1995. Mercury contaminated sites – Behavior of mercury and its species in lysimeter experiments. Water, Air, Soil Pollut. 80: 1089-1098.
- Henderson, P.J.; McMartin, I. 1995. Mercury distribution in humus and surficial sediments, Flin Flon, Manitoba, Canada. Water, Air, Soil Pollut. 80: 1043-1046.
- Hendrickson, O.Q.; Chatarpaul, L.; Burgess, D. 1989. Nutrient cycling following whole-tree and conventional harvest in northern mixed forest. Can. J. For. Res. 19: 725-735.
- Hessen, D.O.; Andersen, T.; Lyche, A. 1990. Carbon metabolism in a humic lake: pool sizes and cycling through zooplankton. Limnol. Oceanogr. 35: 84-99.
- Hintelmann, H.; Welbourn, P.M.; Evans, R.D. 1995. Binding of methylmercury compounds by humic and fulvic acids. Water, Air, Soil Pollut. 80: 1031-1034.
- Hinton, M.J.; Schiff, S.L.; English, M.C. 1997. The significance of storms for the concentration and export of dissolved organic carbon from two Precambrian Shield catchments. Biogeochem. 36: 67-88.
- Hobbie, J.E.; Likens, G.E. 1973. Output of phosphorus, dissolved organic carbon, and fine particulate carbon from Hubbard Brook watersheds. Limnol. Oceanogr. 18: 734-742.

- Hogstrom, U.; Enger, L.; Svedung, I. 1979. A study of atmospheric mercury dispersion. *Atmos. Environ.* 13: 465-476.
- Holm, H.W.; Cox, M.F. 1974. Mercury in aquatic systems: methylation, oxidation-reduction, and bioaccumulation. National Environmental Research Center, US-EPA, ROAP 21 AIM, Task 11, Program Element 1BA023.
- Hornbeck, J.W.; Martin, C.W.; Pierce, R.S.; Bormann, F.H.; Likens, G.E.; Eaton, J.S. 1986. Clearcutting northern hardwoods: effects on hydrologic and nutrient ion budgets. *For. Sci.* 32: 667-686.
- Horvat, M.; Byrne, A.R.; May, K. 1990. A modified method for the determination of methylmercury by gas chromatography. *Talanta* 37: 207-212.
- Horvat, M.; Bloom, N.S.; Liang, L. 1993a. Comparison of distillation with other current isolation methods for the determination of methylmercury compounds in low-level environmental samples. Part I. Sediments. *Anal. Chim. Acta* 281: 135-152.
- Horvat, M.; Liang, L.; Bloom, N.S. 1993b. Comparison of distillation with other current isolation methods for the determination of methylmercury compounds in low-level environmental samples. Part II. Water. *Anal. Chim. Acta* 282: 153-168.
- Hultberg, H.; Iverfeldt, A. 1992. Accumulation and output of methylmercury from forested catchments in Southwestern Sweden. International Conference on Mercury as a Global Pollutant, Monterey, CA. Abstract.
- Hultberg, H.; Iverfeldt, A.; Lee, Y.H.; 1994. Methylmercury input/output and accumulation in forested catchments and critical loads for lakes in Southwestern Sweden. In: C.J. Watras and J.W. Huckabee (eds.). *Mercury Pollution: Integration and Synthesis*. Lewis Publishers, Chelsea, MI. 727 p. pp. 313-322.
- Hunter, M.L., Jr. 1993. Natural fire regimes as spatial models for managing boreal forests. *Biol. Conserv.* 65: 115-120.
- Hurley, J.P.; Watras, C.J.; Bloom, N.S. 1991. Mercury cycling in a northern Wisconsin seepage lake: the role of particulate matter in vertical transport. *Water, Air, Soil Pollut.* 56: 543-551.
- Hurley, J.P.; Krabbenhoft, D.P.; Babiarz, C.L.; Andren, A.W. 1993. Cycling of mercury across the sediment-water interface in seepage lakes. In: L.A. Baker (ed.). *Environmental Chemistry of Lakes and Reservoirs*. American Chemical Society, Washington, DC.
- Hurley, J.P.; Watras, C.J.; Bloom, N.S. 1994. Distribution and flux of particulate mercury in four stratified seepage lakes. In: C.J. Watras and J.W. Huckabee (eds.). *Mercury Pollution: Integration and Synthesis*. Lewis Publishers, Chelsea, MI. 727 p. pp. 69-82.
- Hurley, J.P.; Benoit, J.M.; Babiarz, C.L.; Shafer, M.M.; Andren, A.W.; Sullivan, J.R.;

- Hammond, R.; Webb, D.A. 1995. Influences of watershed characteristics on mercury levels in Wisconsin rivers. *Env. Sci. Technol.* 29: 1867-1875.
- Insam, H. 1990. Are the soil microbial biomass and basal respiration governed by the climatic regime? *Soil Biol. Biochem.* 22: 525-532.
- Irukayama, K. 1967. The pollution of Minamata Bay and Minamata disease. *Adv. Wat. Pollut. Res.* 3: 153-183.
- Iverfeldt, A. 1991. Occurrence and turnover of atmospheric mercury over the Nordic countries. *Water, Air, Soil Pollut.* 56: 251-265.
- Jackson, T.A. 1984. Effects of inorganic cadmium, zinc, copper, and mercury on methyl mercury production in polluted lake sediments: evidence for selective inhibition and stimulation of microbial species based on variations in heavy metal tolerance. In: J.O. Nriagu (ed.). *Environmental Impacts of Smelters*. John Wiley and Sons, Chichester, UK. 608 p. pp. 551-576.
- Jackson, T.A. 1986. Methyl mercury levels in a polluted prairie river-lake system: seasonal and site-specific variations, and the dominant influence of trophic conditions. *Can. J. Fish. Aquat. Sci.* 43: 1873-1886.
- Jackson, T.A. 1988. The mercury problem in recently formed reservoirs of Northern Manitoba (Canada): effects of impoundment and other factors on the production of methylmercury by microorganisms in sediment. *Can. J. Fish. Aquat. Sci.* 45: 97-121.
- Jackson, T.A. 1989. The influence of clay minerals, oxides, and humic matter on the methylation and demethylation of mercury by microorganisms in freshwater sediments. *Appl. Organomet. Chem.* 3: 1-30.
- Jackson, T.A. 1991. Biological and environmental control of mercury accumulation by fish in lakes and reservoirs of Northern Manitoba, Canada. *Can. J. Fish. Aquat. Sci.* 48: 2449-2470.
- Jackson, T.A. 1993. Effects of environmental factors and primary production on the distribution and methylation of mercury in a chain of highly eutrophic riverine lakes. *Water Poll. Res. J. Can.* 28: 177-216.
- Jernelov, A.; Ramel, C. 1994. Mercury in the environment. *Ambio* 23: 166.
- Jernelov, A.; Ramel, C. 1995. Evaluation of the role and distribution of mercury in ecosystems with special emphasis on tropical regions. A SCOPE Project. *Ambio* 24: 319-320.
- Jewett, K.; Daugharty, D.; Krause, H.H.; Arp, P.A. 1995. Watershed responses to clear-cutting: effects on soil solution and stream water discharge in Central New Brunswick. *Can. J. Soil Sci.* 75: 475-490.
- Johannessen, M.; Henriksen, A. 1978. Chemistry of snow meltwater: Changes in concentration

- during melting. *Water Resour. Res.* 14: 615-619.
- Johansson, K.; Iverfeldt, A. 1991. Factors influencing the run off of mercury from small watersheds in Sweden. *Verh. Int. Verein. Limnol.* 24: 2200-2202.
- Johansson, K.; Aastrup, M.; Andersson, A.; Bringmark, L.; Iverfeldt, A. 1991. Mercury in Swedish forest soils and waters - assessment of critical load. *Water, Air, Soil Pollut.* 56: 267-281.
- Johnson, C.E.; Johnson, A.H.; Siccama, T.G. 1991. Whole-tree cutting effects on exchangeable cations and soil acidity. *Soil Soc. Am. J.* 55: 502-508.
- Johnston, T.A.; Bodaly, R.A.; Mathias, J.A. 1991. Predicting fish mercury levels from physical characteristics of boreal reservoirs. *Can. J. Fish. Aquat. Sci.* 48: 1468-1475.
- Jones, R.D.; Jacobson, M.E.; Jaffe, R.; West-Thomas, J.; Arfstrom, C.; Alli, A. 1995. Method development and sample processing of water, soil, and tissue for the analysis of total and organic mercury by cold vapor atomic fluorescence spectrometry. *Water, Air, Soil Pollut.* 80: 1285-1294.
- Jordan, C.F. 1985. *Nutrient Cycling in Tropical Forest Ecosystems.* John Wiley & Sons, Chichester, UK. 190 p.
- Kaärrik, A.A. 1974. Decomposition of wood. In: C.H. Dickinson and G.J. Pugh (eds.). *Biology of Plant Litter Decomposition.* Vol. 1. Academic Press, London. pp. 129-174.
- Kaiser, J. 1996. Agencies debate safe mercury levels in fish. *Science* 271: 104.
- Kalbitz, K.; Wennrich, R. 1998. Mobilization of heavy metals and arsenic in polluted wetland soils and its dependence on dissolved organic matter. *Sci. Total Environ.* 209: 27-39.
- Keenan, R.J.; Kimmins, J.P. 1993. The ecological effects of clear-cutting. *Environ. Rev.* 1: 121-144.
- Kerndorff, H.; Schitzer, M. 1980. Sorption of metals on humic acid. *Geochim. Cosmochim. Acta* 44: 1701- 1708.
- Khanna, P.K. 1981. Leaching of nitrogen from terrestrial ecosystems – Patterns, mechanisms and ecosystem responses. In: F.E. Clark and T. Rosswall (eds.). *Terrestrial Nitrogen Cycles.* *Ecol. Bull. (Stockholm)* 33. 714 p. pp. 343-352.
- Kleber, R.J.; Zhou, X.; Mopper, K. 1990. Formation of carbonyl compounds from UV-induced photodegradation of humic substances in natural waters: Fate of riverine carbon in the sea. *Limnol. Oceanogr.* 35: 1505-1515.
- Kilgore, B.M. 1973. The ecological role of fire in Sierran conifer forests: its application to National Park Management. *Quat. Res.* 3: 496-513.
- Kilgore, B.M. 1981. *Fire in ecosystem distribution and structure: western forests and scrublands.*

- In: H.A. Mooney, T.M. Bonnicksen, N.L. Christensen, J.E. Lotan, W.A. Reiners (eds.). *Fire Regimes and Ecosystem Properties*. USDA Forest Service Gen. Technical Report, WO-26.
- Killops, S.; Killops, V. 1993. *An Introduction to Organic Geochemistry*. Longman Scientific and Technical, London, UK. 265 p.
- Klein, S.M.; Jacobs, L.A. 1995. Distribution of mercury in the sediments of Onondaga Lake, N.Y. *Water, Air, Soil Pollut.* 80: 1035-1038.
- Kolka, R.K.; Grigal, D.F.; Verry, E.S.; Nater, E.A. 1999. Mercury and organic carbon relationships in streams draining forested upland/peatland watersheds. *J. Environ. Qual.* 28: 766-775.
- Krabbenhoft, D.P.; Babiarz, C.L. 1992. The role of groundwater transport in aquatic mercury cycling. *Water Resour. Res.* 28: 3119-3128.
- Krabbenhoft, D.P.; Benoit, J.M.; Babiarz, C.L.; Hurley, J.P.; Andren, A.W. 1995. Mercury cycling in the Allequash Creek Watershed, Northern Wisconsin. *Water, Air, Soil Pollut.* 80: 425-433.
- Krause, H.H. 1982. Nitrate formation and movement before and after clearcutting of a monitored watershed in central New Brunswick, Canada. *Can. J. For. Res.* 12: 922-930.
- Landa, E.R. 1978. The retention of metallic mercury vapor by soils. *Geochim. Cosmochim. Acta* 42: 1407-1411.
- Langlois, C.; Langis, R.; Pérusse, M. 1995. Mercury contamination in Northern Quebec environment and wildlife. *Water, Air, Soil Pollut.* 80: 1021-1025.
- Langmuir, D. 1997. *Aqueous Environmental Geochemistry*. Prentice Hall, Upper Saddle River, NJ. 600 pp.
- Lansens, P.; Meuleman, C.; Baeyens, W. 1990. Long-term stability of methylmercury standard solutions in distilled, deionized water. *Anal. Chim. Acta* 229: 281-285.
- Lazerte, B.D. 1983. Stable carbon isotope ratios: implications for the source of sediment carbon and for phytoplankton carbon assimilation in lake Memphremagog, Quebec. *Can. J. Fish. Aquat. Sci.* 40: 1658-1666.
- Lee, Y.H.; Mowrer, J. 1989. Determination of methylmercury in natural waters at the sub-nanograms per litre level by capillary gas chromatography after adsorbent preconcentration. *Anal. Chim. Acta* 221: 259-268.
- Lee, Y.H.; Hultberg, H. 1990. Methylmercury in some Swedish surface waters. *Environ. Toxicol. Chem.* 9: 833-841.
- Lee, Y.H.; Iverfeldt, A. 1991. Measurement of methylmercury and mercury in runoff, lake and rain waters. *Water, Air, Soil Pollut.* 56: 309-321.

- Liang, L.; Horvat, M.; Bloom, N.S. 1994. An improved speciation method for mercury by GC/CVAFS after aqueous phase ethylation and room temperature precollection. *Talanta* 41: 371-379.
- Liang, L.; Horvat, M.; Cernichiari, E.; Gelein, B.; Balogh, S. 1996. Simple solvent extraction technique for elimination of matrix interferences in the determination of methylmercury in environmental and biological samples by ethylation - gas chromatography - cold vapor atomic fluorescence spectrometry. *Talanta* 43: 1883-1888.
- Likens, G.E.; Bormann, F.H.; Johnson, N.M.; Fisher, D.W.; Pierce, R.S. 1970. Effects of forest cutting and herbicide treatment on nutrient budgets in the Hubbard Brook watershed - ecosystem. *Ecol. Monogr.* 40: 23-47.
- Lindqvist, O.; Rodhe, H. 1985. Atmospheric mercury: a review. *Tellus* 37B: 136-159.
- Lindqvist, O.; Johansson, K.; Aastrup, M.; Andersson, A.; Bringmark, L.; Hovsenius, G.; Hakanson, L.; Iverfeld, A.; Meili, M.; Timm, B. 1991. Mercury in the Swedish environment. *Water, Air, Soil Pollut.* 55: 1-48.
- Lodenius, M.; Seppänen, A.; Uusi-Rauva, A. 1983. Sorption and mobilization of mercury in peat soil. *Chemosph.* 12: 1575-1586.
- Lodenius, M. 1994. Mercury in terrestrial ecosystems: a review. In: C.J. Watras and J.W. Huckabee (eds.). *Mercury Pollution: Integration and Synthesis*. Lewis Publishers, Chelsea, MI. 727 pp. p. 343-354.
- Lodenius, M.; Seppänen, A.; Autio, S. 1987. Sorption of mercury in soils with different humus content. *Bull. Environ. Contam. Toxicol.* 39: 593-600.
- Lodenius, M.; Tulisalo, E. 1984. Environmental mercury contamination around a chlor-alkali plant. *Bull. Environ. Contam. Toxicol.* 32: 439-444.
- Louchouart, P.; Lucotte, M.; Mucci, A.; Pichet, P. 1993. Geochemistry of mercury in two hydroelectric reservoirs in Quebec, Canada. *Can. J. Fish. Aquat. Sci.* 50: 269-281.
- Lucotte, M.; Ferland, P.; Fortin, B.; Grondin, A.; Hillaire-Marcel, C.; Louchouart, P.; Mucci, A.; Pichet, P. 1992. Transport atmosphérique à la longue distance du mercure et du plomb des sédiments lacustres du Québec. *Bull. Aqua* 18: 53-56.
- Lucotte, M.; Mucci, A.; Hillaire-Marcel, C.; Pichet, P.; Grondin, A. 1995. Anthropogenic mercury enrichment in remote lakes of Northern Québec (Canada). *Water, Air Soil Pollut.* 80: 467-476.
- Mackay, D.; Wania, F.; Schroeder, W.H. 1995. Prospects for modeling the behavior and fate of mercury, globally and in aquatic systems. *Water, Air, Soil Pollut.* 80: 941-950.
- Malmer, A. 1990. Stream suspended sediment load after clear-felling and different forestry

- treatments in tropical rainforest, Sabah, Malaysia. In: **Research Needs and Applications to Reduce Erosion and Sedimentation in Tropical Steeplands**. Int. Assoc. Hydrol. Sci. Assoc. Int. Sci. Hydrol. Publ. 193: 62-71.
- Margalef, R. 1997. **Our Biosphere. Excellence in Ecology**, No. 10. Ecology Institute, Oldendorf, Germany. 176 p.
- Martin, M.H.; Coughtry, P.J. 1981. **Impact of metals on ecosystem function and productivity**. In: N.W. Lepp (ed.). **Effect of Heavy Metal Pollution in Plants**. Vol. 2. Applied Science Publishers, London., UK. pp. 119-158.
- Mason, R.P.; Morel, F.M.M.; Hemond, H.F. 1995. **The role of microorganisms in elemental mercury formation in natural waters**. *Water, Air, Soil Pollut.* 80: 775-787.
- Matilainen, T. 1995. **Involvement of bacteria in methylmercury formation in anaerobic lake waters**. *Water, Air, Soil Pollut.* 80: 757-764.
- Matilainen, T.; Verta, M.; Niemi, M.; Uusi-Rauva, A. 1991. **Specific rates of net methylmercury production in lake sediments**. *Water, Air, Soil Pollut.* 56: 595-605.
- Matthews, S.L.; McCracken, I.P.; Lonergan, G. 1995. **Mercury contamination of golf courses due to pesticide use**. *Bull. Environ. Contam. Toxicol.* 55(3): 390-397.
- McColl, J.G. 1972. **Dynamics of ion transport during moisture flow from a Douglas-fir forest floor**. *Soil Sci. Soc. Am. J.* 42: 358-363.
- McDowell, W.H.; Fisher, S.G. 1976. **Autumnal processes of dissolved organic matter in a small woodland stream ecosystem**. *Ecol.* 57: 561-569.
- McFarlane, B.L.; Boxall, P.C.; Adamowicz, W. 1998. **Big game hunters in Alberta: their activities, values, and preferences in relation to sustainable forest management**. Sustainable Forest Management Network of Centers of Excellence. Working Paper 1998-4.
- McMurtry, M.J.; Wales, D.L.; Scheider, W.A.; Beggs, G.L.; Dimond, P.E. 1989. **Relationship of mercury concentrations in lake trout (*Salvelinus namaycush*) and smallmouth bass (*Micropterus dolomieu*) to the physical and chemical characteristics of Ontario lakes**. *Can. J. Fish. Aquat. Sci.* 46: 426-434.
- Meili, M. 1991a. **The coupling of mercury and organic matter in the biogeochemical cycle: towards a mechanistic model for the boreal forest zone**. *Water, Air, Soil Pollut.* 56: 333-347.
- Meili, M. 1991b. **Fluxes, pools, and turnover of mercury in Swedish forest lakes**. *Water, Air, Soil Pollut.* 56: 719-727.
- Meili, M. 1991c. **Mercury in forest lake ecosystems – bioavailability, bioaccumulation and biomagnification**. *Water, Air, Soil Pollut.* 55: 131-157.
- Meili, M. 1992. **Sources, concentrations and characteristics of organic matter in softwater lakes**

- and streams of the Swedish forest region. *Hydrobiol.* 229: 23-41.
- Meili, M.; Iverfeldt, A.; Hakanson, L. 1991. Mercury in the surface waters of Swedish forest lakes: concentrations, speciation and controlling factors. *Water, Air, Soil Pollut.* 56: 439-453.
- Meili, M.; Parkman, H. 1988. Seasonal mercury accumulation patterns in mesoplankton. *Verh. Int. Ver. Limnol.* 23: 1639-1640.
- Meyer, J.L.; Tate, C.M. 1983. The effects of watershed disturbance on dissolved organic carbon dynamics of a stream. *Ecol.* 64: 33-44.
- Mierle, G. 1990. Aqueous inputs of mercury to Precambrian Shield lakes in Ontario. *Environ. Toxicol. Chem.* 9: 843-851.
- Mierle, G.; Ingram, R. 1991. The role of humic substances in the mobilization of mercury from watersheds. *Water, Air, Soil Pollut.* 56: 349-357.
- Miskimmin, B.M.; Rudd, J.W.M.; Kelly, C.A. 1992. Influence of dissolved organic carbon, pH, and microbial respiration rates on mercury methylation and demethylation in lake water. *Can. J. Fish. Aquat. Sci.* 49: 17-22.
- Moore, T.R. 1989. Dynamics of dissolved organic carbon in forested and disturbed catchments, Westland, New Zealand. 1. Maimai. *Water Resour. Res.* 25(6):1321-1330.
- Moore, T.R.; Jackson, R.J. 1989. Dynamics of dissolved organic carbon in forested and disturbed catchments, Westland, New Zealand. 2. Larry River. *Water Resour. Res.* 25(6): 1331-1339.
- Morrison, K.A.; Thérien, N. 1995. Fluxes of mercury through biota in the LG-2 reservoir after flooding. *Water, Air, Soil Pollut.* 80: 573-576.
- Mroz, G.D.; Jurgensen, M.F.; Frederick, D.J. 1985. Soil nutrient changes following whole-tree harvesting on three northern hardwood sites. *Soil Sci. Soc. Am. J.* 49: 1552-1557.
- Mucci, A.; Lucotte, M.; Montgomery, S.; Plourde, Y.; Pichet, P.; Van Tra, H. 1995. Mercury remobilization from flooded soils in a hydroelectric reservoir of northern Quebec, La Grande-2: results of a soil resuspension experiment. *Can. J. Fish. Aquat. Sci.* 52: 2507-2517.
- Mulholland, P.J. 1981. Organic carbon flow in a swamp-stream ecosystem. *Ecol. Monogr.* 51: 307-322.
- Naiman, R.J. 1982. Characteristics of sediment and organic carbon export from pristine boreal forest watersheds. *Can. J. Fish. Aquat. Sci.* 39: 1699-1718.
- Nater, E.A.; Grigal, D.F. 1992. Regional trends in mercury distribution across the Great Lakes states, north central USA. *Nature* 358: 139-141.
- Nishimura, H.; Kumagai, M. 1983. Mercury pollution of fishes in Minamata bay and surrounding water: analysis of pathways of mercury. *Water, Air, Soil Pollut.* 20: 401-411.

- Nriagu, J.O. 1989. A global assessment of natural sources of atmospheric trace metals. *Nature* 338: 47-48.
- Nriagu, J.O.; Pacyna, J.M. 1988. Quantitative assessment of worldwide contamination of air, water, and soil by trace metals. *Nature* 333: 134-138.
- Nusch, E.A. 1980. Comparison of different methods for chlorophyll and phaeopigment determination. *Arch. Hydrobiol. Beih. Ergebn. Limnol.* 14: 14-36.
- Nykvist, N.; Rosén, K. 1985. Effect of clear-felling and slash removal on the acidity of northern coniferous soils. *For. Ecol. Manag.* 11: 157-169.
- Oliver, C.D.; Larson, B.C. 1990. *Forests Stand Dynamics*. McGraw-Hill, New York, NY. 467 pp.
- OMOE; OMNR. 1993. *Guide to Eating Ontario Sport Fish*. Ontario Ministry of the Environment (OMOE); Ontario Ministry of Natural Resources (OMNR), Toronto, ON.
- Oremland, R.S.; Culbertson, C.W.; Winfrey, M.R. 1991. Methylmercury decomposition in sediments and bacterial cultures: involvement of methanogens and sulfate reducers in oxidative demethylation. *Appl. Environ. Microbiol.* 57: 130-137.
- Oremland, R.S.; Miller, L.G.; Dowdle, P.; Connell, T.; Barkay, T. 1995. Methylmercury oxidative degradation potentials in contaminated and pristine sediments of the Carson River, Nevada. *Appl. Environ. Microbiol.* 61: 2745-2753.
- Ovington, J.D. 1962. Quantitative ecology and the woodland ecosystem concept. *Adv. Ecol. Res.* 1: 103-192.
- Panda, K.K.; Lenka, M.; Panda, B.B. 1992. Monitoring and assessment of mercury pollution in the vicinity of a chlor-alkali plant. II. Plant-availability, tissue-concentration and genotoxicity of mercury from agricultural soil contaminated with solid waste assessed in barley (*Hordeum vulgare* L.). *Environ. Poll.* 76: 33-42.
- Parkman, H.; Meili, M. 1993. Mercury in macroinvertebrates from Swedish forest lakes: influence of lake type, habitat, life cycle and food quality. *Can. J. Fish. Aquat. Sci.* 50: 521-534.
- Parkman, H.; Östlund, P.; Samuelsson, M.O.; Iverfeldt, A. 1994. Methylmercury in a permanently stratified fjord. In: C.J. Watras and J.W. Huckabee (eds.) *Mercury Pollution: Integration and Synthesis*. Lewis Publishers, Chelsea, MI. 727 p. pp. 107-118.
- Paquette, K.; Helz, G. 1995. Solubility of cinnabar (red HgS) and implications for mercury speciation in sulfidic waters. *Water, Air, Soil Pollut.* 80: 1053-1056.
- Patric, J.H. 1976. Soil erosion in the eastern forest. *J. For.* 74: 671-677.
- Patric, J.H. 1980. Effects of wood products harvest on forest soils and water relations. *J. Environ. Qual.* 9: 73-80.

- Payette, S.; Filion, L.; Delwaide, A. 1990. Disturbance regime of a cold temperate forest as deduced from tree-ring patterns: the Tantaré Ecological Reserve, Québec. *Can. J. For. Res.* 20: 1228-1241.
- Pettersson, C.; Bishop, K.; Lee, Y.H.; Allard, B. 1995. Relations between organic carbon and methylmercury in humic-rich surface waters from Svartberg catchment in Northern Sweden. *Water, Air, Soil Pollut.* 80: 971-979.
- Pfeiffer, W.C.; Malm, O.; Souza, C.M.M.; Drude de Lacerda, L.; Silveira, E.G.; Bastos, W.R. 1991. Mercury in the Madeira River ecosystem, Rondônia, Brazil. *For. Ecol. Manag.* 38: 239-245.
- Planas, D. 1999. Comparison of the Effects of Fires and Logging on Algal Productivity, Quality and Biodiversity in Boreal Shield Lakes. Project Rep. Sustainable Forest Management Network, Edmonton, AB. 20 p.
- Plourde, Y.; Lucotte, M.; Pichet, P. 1997. Contribution of suspended particulate matter and zooplankton to methylmercury contamination of the food chain in midnorthern Quebec (Canada) reservoirs. *Can. J. Fish. Aquat. Sci.* 54: 821-831.
- Ponce, R.A.; Bloom, N.S. 1991. Effect of pH on the bioaccumulation of low level, dissolved methylmercury by rainbow trout (*Oncorhynchus mykiss*). *Water, Air, Soil Pollut.* 56: 631-640.
- Porvari, P.; Verta, M. 1995. Methylmercury production in flooded soils: a laboratory study. *Water, Air, Soil Pollut.* 80: 765-773.
- Powers, R.F.; Alban, D.H.; Miller, R.E.; Triarks, A.E.; Wells, C.G.; Avers, P.E.; Cline, R.G.; Loftus, N.S., Jr.; Fitzgerald, F.O. 1990. Sustaining productivity in North American forests: problems and prospects. In: S.P. Gessel; D.S. Lacate; G.F. Weetman; Powers, R.F. Sustained Productivity of Forest Soils. University of British Columbia, Vancouver, BC. 525 p. pp. 49-79.
- Preston, M.R. 1989. Marine Pollution. In: Riley, J.P. Chemical Oceanography. V. 9. Academic Press, Oxford. 258 p. pp. 136-197.
- Quémerais, B.; Cossa, D. 1995. Protocoles d'échantillonnage et d'analyse du mercure dans les eaux naturelles. Environnement Canada. 40 p.
- Ramlal, P.S.; Rudd, J.W.M.; Hecky, R.E. 1986. Methods for measuring specific rates of mercury methylation and degradation and their use in determining factors controlling net rates of mercury methylation. *Appl. Environ. Microbiol.* 51: 110-114.
- Ramlal, P.S.; Kelly, C.A.; Rudd, J.W.M.; Furutani, A. 1993. Sites of methylmercury production in remote Canadian Shield lakes. *Can. J. Fish. Aquat. Sci.* 50: 972-979.

- Rashid, M.A. 1985. *The Geochemistry of Marine Humic Compounds*. Springer-Verlag, New York, NY. 300 p.
- Rask, M.; Metsala, T.J.; Salonen, K. 1994. Mercury in the food chains of a small polyhumic forest lake in southern Finland. In: C.J. Watras and J.W. Huckabee (eds.). *Mercury Pollution: Integration and Synthesis*. Lewis Publishers, Chelsea, MI. 727 pp. p. 409-416.
- Regnell, O.; Tunlid, A. 1991. Laboratory study of chemical speciation of mercury in lake sediment and water under aerobic and anaerobic conditions. *Appl. Environ. Microbiol.* 57: 789-795.
- Reimers, R.S.; Krenkel, P.A. 1974. Kinetics of mercury adsorption and desorption in sediments. *Water Poll. Con. Fed. J.* 46: 352-365.
- Rennie, P.J. 1955. The uptake of nutrients by mature forest growth. *Plant Soil* 7: 49-95.
- Rissanen, K. 1972. Toxicology and metabolism of mercury and methylmercury in man. National Workshop on Mercury in Man, Ottawa, ON. 18 pp.
- Roberts, R.G.; Church, M. 1986. The sediment budget in severely disturbed watersheds, Queen Charlotte Ranges, British Columbia. *Can. J. For. Res.* 16: 1092-1106.
- Rosén, K.; Aronson, J.A.; Eriksson, H.M. 1996. Effects of clear-cutting on streamwater quality in forest catchments in central Sweden. *For. Ecol. Manag.* 83: 237-244.
- Rothacher, J. 1970. Increase in water yield following clear-cut logging in the Pacific Northwest. *Water Resour. Res.* 6: 653-658.
- Roulet, M.; Lucotte, M. 1995. Geochemistry of mercury in pristine and flooded ferralitic soils of a tropical rain forest in French Guiana, South America. *Water, Air, Soil Pollut.* 80: 1079-1088.
- Roulet, M.; Lucotte, M.; Farella, N.; Serique, Coelho, H.; Sousa Passos, C.J.; de Jesus da Silva, E.; Scavone de Andrade, P.; Mergler, D.; Guimarães, J.R.D.; Amorim, M. 1998a. Effects of recent human colonization on the presence of mercury in Amazonian ecosystems. *Water, Air, Soil Pollut.* 112: 297-313.
- Roulet, M.; Lucotte, M.; Canuel, R.; Rheault, I.; Tran, S.; de Freitas, Y.; Farella, N.; Souza, R.; Passos, C.J.; de Jesus, E.; Mergler, D.; Amorim, M. 1998b. Distribution and partition of total mercury in waters of the Tapajós River Basin, Brazilian Amazon. *Sci. Total Environ.* 219: 209-221.
- Roulet, M.; Lucotte, M.; Saint-Aubin, A.; Tran, S.; Rheault, I.; Farella, N.; de Jesus da Silva, E.; Dezencourt, J.; Sousa Passos, C.J.; Santos Soares, G.; Guimarães, J.R.; Mergler, D.; Amorim, M. 1998c. The geochemistry of Hg in Central Amazonian soils developed on the Alter-do-Chão formation on the Lower Tapajós River Valley, Pará State, Brazil. *Sci. Total*

- Environ. 223: 1-24.
- Rubin, P.G.; Yu, M.G. 1996. Mercury vapor in amalgam waste discharged from dental office vacuum units. *Arch. of Environ. Health* 51: 335-337.
- Rudd, J.W.M. 1995. Sources of methylmercury to freshwater ecosystems: a review. *Water, Air, Soil Pollut.* 80: 697-713.
- Ruth, R.H. 1967. Silvicultural effects of skyline crane and high-lead yarding. *J. For.* 65: 251-255.
- Sartory, D.P.; Grobelaar, J.U. 1984. Extraction of chlorophyll-a from freshwater phytoplankton for spectrophotometric analysis. *Hydrobiol.* 114: 177-187.
- Schiff, S.L.; Aravena, R.; Trumbore, S.E.; Hinton, M.J.; Elgood, R.; Dillon, P.J. 1997. Export of DOC from forested catchments on the Precambrian Shield of Central Ontario: clues from ^{13}C and ^{14}C . *Biogeochem.* 36: 43-65.
- Schlesinger, W.H. 1984. Soil organic matter: a source of atmospheric CO_2 . In: G.M. Woodwell (ed.). *The Role of Terrestrial Vegetation in the Global Carbon Cycle: Measurement by Remote Sensing*. John Wiley and Sons, Chichester, UK. 247 p. pp. 111-127.
- Schuster, E. 1991. The behavior of mercury in the soil with special emphasis on complexation and adsorption processes: a review of the literature. *Water, Air, Soil Pollut.* 56: 667-680.
- Scott, J.S. 1980. Geology of Canadian tills. In: R.F. Legget (ed.). *Glacial Till: an Interdisciplinary Study*. R. Soc. Can. Spec. Publ. No. 12. pp. 50-66.
- Scott, D.F.; van Wyk, D.B. 1992. The effects of fire on the soil water repellency, catchment sediment yields and streamflow. In: B.W. van Wilgen; D.M. Richardson; F.J. Kruger; H.J. van Hensbergen (eds.). *Fire in South African Mountain Fynbos: Ecosystem, Community and Species Response at Swartboskloof*. Ecological Studies, vol. 93. Springer-Verlag, Berlin, Germany. 325 p. pp. 216-239.
- Seastedt, T.R.; Crossley, D.A. 1981. Microarthropod response following cable logging and clear-cutting in the southern Appalachians. *Ecol.* 62: 126-135.
- Semu, E.; Singh, B.R.; Selmer-Olsen, A.R. 1987. Adsorption of mercury compounds by tropical soils II – Effect of soil: solution ratio, ionic strength, pH, and organic matter. *Water, Air, Soil Pollut.* 32: 1-10.
- Severson, R.C.; Gough, L.P.; Van den Boom, G. 1992. Baseline element concentration in soils and plants, Wattenmeer National Park, north and east Frisian islands, Federal Republic of Germany. *Water, Air, Soil Pollut.* 61: 169-184.
- Sheppard, S.C.; Evenden, W.G.; Schwartz, W.J. 1995. Heavy metals in the environment - Ingested soil: bioavailability of sorbed lead, cadmium, cesium, iodine, and mercury. *J. Environ. Qual.* 24: 498-505.

- Shure, D.J.; Phillips, D.L. 1987. Litter fall pattern within different-sized disturbance patches in a southern Appalachian mountain forest. *Amer. Midl. Naturalist* 118: 348-357.
- Siriraks, A.; Kingston, H.M.; Riviello, J.M. 1990. Chelation ion chromatography as a method for trace elemental analysis in complex environmental and biological samples. *Anal. Chem.* 62: 1185-1193.
- Slemr, F.; Seiler, W.; Schuster, G. 1981. Latitudinal distribution of mercury over the Atlantic Ocean. *J. Geophys. Res.* 86: 1159-1166.
- Slemr, F.; Langer, F. 1992. Increase in global atmospheric concentrations of mercury inferred from measurements over the Atlantic Ocean. *Nature* 355: 434-437.
- Smethurst, P.J.; Nambiar, E.K.S. 1990. Distribution of carbon and nutrients and fluxes of mineral nitrogen after clearfelling a *Pinus radiata* plantation. *Can. J. For. Res.* 20: 1490-1499.
- Sollins, P.; McCorson, F.M. 1981. Nitrogen and carbon solution chemistry of an old growth coniferous forest watershed before and after cutting. *Water Res. Bull.* 17: 1409-1418.
- Sopper, W.E. 1975. Effects of timber harvesting and related management practices on water quality in forested watersheds. *J. Environ. Qual.* 4: 24-29.
- St. Louis, V.L.; Rudd, J.W.M.; Kelly, C.A.; Barrie, L.A. 1994a. Wet deposition of methylmercury in Northwestern Ontario compared to other geographic locations. *Water, Air, Soil Pollut.* 80: 405-414.
- St. Louis, V.L.; Rudd, J.W.M.; Kelly, C.A.; Beaty, K.G.; Bloom, N.S.; Flett, R.J. 1994b. Importance of wetlands as sources of methyl mercury to boreal forest ecosystems. *Can. J. Fish. Aquat. Sci.* 51: 1065-1076.
- St. Louis, V.L.; Rudd, J.W.M.; Kelly, C.A.; Beaty, N.S.; Flett, R.J.; Roulet, N.T. 1996. Production and loss of methylmercury and loss of total mercury from boreal forest catchments containing different types of wetlands. *Env. Sci. Technol.* 30: 2719-2729.
- Staaf, H.; Berg, B. 1981. Plant litter input to soil. In: F.E. Clark and T. Rosswall (eds.). *Terrestrial Nitrogen Cycles. Ecol. Bull. (Stockholm)* 33: 147-162.
- Staaf, H.; Olson, B.A. 1991. Acidity in four coniferous forest soils after different harvesting regimes of logging slash. *Scand. J. For. Res.* 6: 19-29.
- Steffan, R.J.; Korthals, E.T.; Winfrey, M.R. 1988. Effects of acidification on mercury methylation, demethylation, and volatilization in sediments from an acid-susceptible lake. *Appl. Environ. Microbiol.* 54: 2003-2009.
- Stoeppler, M.; Matthes, W. 1978. Storage behavior of inorganic mercury and methylmercury chloride in sea water. *Anal. Chim. Acta* 98: 389-392.
- Stumm, W.; Morgan, J.J. 1996. *Aquatic Chemistry: Chemical Equilibria and Rates in Natural*

- Waters. John Wiley and Sons, New York, NY. 1022 p.
- Suchanek, T.H.; Richerson, P.J.; Holts, L.J.; Lamphere, B.A.; Woodmansee, C.E.; Slotton, D.G.; Harner, E.J.; Woodward, L.A. 1995. Impacts of mercury on benthic invertebrate populations and communities within the aquatic ecosystems of Clear Lake, California. *Water, Air, Soil Pollut.* 80: 951-960.
- Swain, E.B.; Engstrom, D.R.; Brigham, M.E.; Henning, T.A.; Brezonik, P.I. 1992. Increasing rates of atmospheric mercury deposition in midcontinental North America. *Science* 257: 784-787.
- Swift, M.J.; Heal, O.W.; Anderson, J.M. 1979. *Decomposition in Terrestrial Ecosystems*. University of California Press. 372 p.
- Szakács, O.; Lásztity, A.; Horváth, Z. 1980. Breakdown of organic mercury compounds by hydrochloric acid-permanganate or bromine monochloride solution for the determination of mercury by cold-vapor atomic absorption spectrometry. *Anal. Chim. Acta* 121: 219-224.
- Thérien, N.; Morrison, K. 1986. Modèle prévisionnel de la qualité des eaux du réservoir hydro-électrique LG-2: considération des zones hydrauliques actives et stagnantes. *Rev. Int. Sci. Eau* 1: 11-17.
- Thibaud, Y. 1990. Bioaccumulation. In: Cossa, D.; Thibaud, Y.; Romeo, M.; Gnassia-Barelli, M. *Le Mercure en Milieu Marin: Biogéochimie et Ecotoxicologie*. 130 p. pp. 53-83.
- Thomas, J.E. 1975a. A numerical study of the hydrologic impact of logging. Master's Thesis, McGill University, Montreal, QC. 150 pp.
- Thomas, J.E. 1975b. An Energy Budget Model of the Coniferous Forest Biome for Determining the Hydrologic Impact of Logging. Publication in Meteorology No. 115, McGill University, Montreal, QC..
- Tiedemann, A.R.; Quigley, T.M.; Anderson, T.D. 1988. Effects of timber harvest on stream chemistry and dissolved nutrient losses in northeast Oregon. *For. Sci.* 34: 344-358.
- Tremblay, A.; Lucotte, M. 1997. Accumulation of total mercury and methyl mercury in insect larvae of hydroelectric reservoirs. *Can. J. Fish. Aquat. Sci.* 54: 832-841.
- Troendle, C.A.; King, R.M. 1987. The effect of partial and clear-cutting on streamflow at Deadhorse Creek, Colorado. *J. Hydrol.* 90: 145-147.
- Trost, P.B.; Bique, R.E. 1970. Distribution of mercury in residual soils. In: R. Hartung and B.D. Dinman (eds.). *Environmental Mercury Contamination*. Ann Arbor Science, Ann Arbor, MI. 349 p. pp. 178-196.
- United States Environmental Protection Agency (US-EPA). 1997. Mercury Study Report to Congress. EPA-452/R-97. Washington, D.C. On-line source. Consulted in March 1998.

<http://www.epa.gov/ttn/uatw/112nmerc/mercury.html>.

- Van Cleve, K.; Alexander, V. 1981. Nitrogen cycling in tundra and boreal ecosystems. In: F.E. Clarke and T. Rosswall (eds.). *Terrestrial Nitrogen Cycles*. Ecol. Bull. (Stockholm) 33: 714p. pp. 375-404.
- Van Lear, D.H.; Douglass, J.E.; Cox, S.K.; Ausperger, M.K. 1985. Sediment and nutrient export from burned and harvested pine watershed in South Carolina piedmont. *J. Environ. Qual.* 14: 169-174.
- Van Reenen, C.A.; Visser, G.J.; Loos, M.A. 1992. Soil microorganisms and activities in relation to season, soil factors and fire. In: B.W. van Wilgen; D.M. Richardson; F.J. Kruger; H.J. van Hensbergen (eds.). *Fire in South African Mountain Fynbos: Ecosystem, Community and Species Response at Swartboskloof*. Ecological Studies, vol. 93. Springer-Verlag, Berlin, Germany. 325 p. pp. 258-272.
- Van Veen, J.A.; McGill, W.B.; Hunt, H.W.; Frissel, M.J.; Cole, C.V. 1981. Simulation models of the terrestrial nitrogen cycle. In: F.E. Clark and T. Rosswall (eds.). *Terrestrial Nitrogen Cycles*. Ecol. Bull. (Stockholm) 33: 25-48.
- Van Wilgen, B.W.; van Hensbergen, H.J. 1992. Fuel properties of vegetation in Swartboskloof. In: B.W. van Wilgen; D.M. Richardson; F.J. Kruger; H.J. van Hensbergen (eds.). *Fire in South African Mountain Fynbos: Ecosystem, Community and Species Response at Swartboskloof*. Ecological Studies, vol. 93. Springer-Verlag, Berlin, Germany. 325 p. pp. 37-53.
- Van Wyk, D.B.; Lesch, W.; Stock, W.D. 1992. Fire and catchment chemical budgets. In: B.W. van Wilgen; D.M. Richardson; F.J. Kruger; H.J. van Hensbergen (eds.). *Fire in South African Mountain Fynbos: Ecosystem, Community and Species Response at Swartboskloof*. Ecological Studies, vol. 93. Springer-Verlag, Berlin, Germany. 325 p. pp. 240-257.
- Verdon, R.; Brouard, D.; Demers, C.; Lalumière, R.; Laperle, M.; Schetagne, R. 1991. Mercury evolution (1978-1988) in fishes of the La Grande hydroelectric complex, Québec, Canada. *Water, Air, Soil Pollut.* 56: 405-417.
- Verta, M.K.; Tolonen, K.; Simola, H. 1989. History of heavy metal pollution in Finland as recorded by lake sediments. *Sci. Total Environ.* 87/88: 1-18.
- Verta, M.; Matilainen, T.; Porvari, P.; Niemi, M.; Uusi-Rauva, A.; Bloom, N.S.: 1994. Methylmercury sources in boreal lake ecosystems. In: C.J. Watras and J.W. Huckabee (eds.). *Mercury Pollution: Integration and Synthesis*. Lewis Publishers, Chelsea, MI. 727 p. pp. 119-136.
- Vincent, J.S. 1989. Le Quaternaire du sud-est du Bouclier canadien. In: Fulton, R.J. *Le*

- Quaternaire du Canada et du Groenland. Commission Géologique du Canada, Ottawa, ON. Vol. 1.
- Vitousek, P.M. 1981. Clear-cutting and the nitrogen cycle. In: F.E. Clark and T. Rosswall (eds.). *Terrestrial Nitrogen Cycles*. Ecol. Bull. (Stockholm) 33: 631-642.
- Vitousek, P.M.; Gosz, J.R.; Grier, C.G.; Melillo, J.M.; Reiners, W.A.; Todd, R.L. 1979. Nitrate losses from disturbed ecosystems. *Science* 204: 469-474.
- Vitousek, P.M.; Matson, P.A. 1985a. Causes of delayed nitrate production in two Indiana forests. *For. Sci.* 31: 122-131.
- Vitousek, P.M.; Matson, P.A. 1985b. Disturbance, nitrogen availability, and nitrogen losses in an intensively managed loblolly pine plantation. *Ecol.* 66: 1360-1376.
- Warren, L.A.; Zimmermann, A.P. 1994. The importance of surface area in metal sorption by oxides and organic matter in a heterogeneous natural sediment. *Appl. Geochem.* 9: 245-254.
- Watras, C.J.; Bloom, N.S. 1992. Mercury and methyl mercury in individual zooplankton: implications for bioaccumulation. *Limnol. Oceanogr.* 37: 1313-1318.
- Watras, C.J.; Bloom, N.S.; Hudson, R.J.M.; Gherini, S.; Munson, R.; Claas, S.A.; Morrison, K.; Hurley, J.; Wiener, J.G.; Fitzgerald, W.F.; Mason, R.; Vandal, G.; Powell, D.; Rada, R.; Rislov, L.; Winfrey, M.; Elder, J.; Krabbenhoft, D.; Andren, A.W.; Babiartz, C.; Porcella, D.B.; Huckabee, J.W. 1994. Sources and fates of mercury and methylmercury in Wisconsin Lakes. In: C.J. Watras and J.W. Huckabee (eds.). *Mercury Pollution: Integration and Synthesis*. Lewis Publishers, Chelsea, MI. 727 pp. p. 153-177.
- Wells, C.G.; Campbell, R.E.; DeBano, L.F.; Lewis, C.E.; Friedriksen, R.L.; Franklin, E.C.; Froelich, R.C.; Dunn, P.H. 1979. Effects of Fire on Soil. U.S. For. Serv. Wash. Off. Gen. Tech. Rep. WO7.
- Westcott, K.; Kalff, J. 1996. Environmental factors affecting methyl mercury accumulation in zooplankton. *Can. J. Fish. Aquat. Sci.* 53: 2221-2228.
- Wetzel, R.G. 1975. *Limnology*. W.B. Saunders Co., Philadelphia, PA. 743 pp.
- Wetzel, R.G. 1992. Gradient-dominated ecosystems: sources and regulatory functions of dissolved organic matter in freshwater ecosystems. *Hydrobiol.* 229: 181-198.
- Wiener, J.G.; Fitzgerald, W.F.; Watras, C.J.; Rada, R.G. 1990. Partitioning and bioavailability of mercury in an experimentally acidified Wisconsin lake. *Environ. Toxicol. Chem.* 9: 909-916.
- Wiklander, G. 1981. Heterogeneous nitrogen leaching after clear-cutting. In: F.E. Clark and T. Rosswall (eds.). *Terrestrial Nitrogen Cycles*. Ecol. Bull. (Stockholm) 33: 642-647.
- Winefordner, J.D.; Long, G.L. 1983. Limit of detection: a closer look at the IUPAC definition. *Anal. Chem.* 55: 712A-724A.

- Winfrey, M.; Rudd, J.W.M. 1990. Environmental factors affecting the formation of methylmercury in low pH lakes: a review. *Environ. Toxicol. Chem.* 9: 853-869.
- Woodmansee, R.G.; Wallach, L.S. 1981. Effects of fire regimes on biogeochemical cycles. In: F.E. Clark and T. Rosswall (eds.). *Terrestrial Nitrogen Cycles. Ecol. Bull. (Stockholm)* 33: 649-669.
- Woodwell, G.M. 1984. The Role of Terrestrial Vegetation in the Global Carbon Cycle: Measurement by Remote Sensing. Section III: Soils. *SCOPE 23*. John Wiley and Sons, Chichester, UK. 247 p. pp. 89-90.
- Xiao, Z.F.; Munthe, J.; Schroeder, W.H.; Lindqvist, O. 1991. Vertical fluxes of volatile mercury over forest soil and lake surfaces in Sweden. *Tellus* 43B: 267-279.
- Xun, L.; Campbell, N.E.R.; Rudd, J.W.M. 1987. Measurements of specific rates of net methylmercury production in the water column and surface sediments of acidified and circumneutral lakes. *Can. J. Fish. Aquat. Sci.* 44: 750-757.
- Yess, N. 1993. U.S. Food and Drug Administration survey of methylmercury in canned tuna. *J. AOAC Int.* 76: 36-38.
- Yin, Y.; Allen, H.E.; Li, Y.; Huang, C.P.; Sanders, P.F. 1996. Heavy metals in the environment – Adsorption of mercury(II) by soil: effects of pH, chloride, and organic matter. *J. Environ. Qual.* 25: 837-844.
- Zhang, L.; Planas, D. 1993. Biotic and abiotic mercury methylation and demethylation in sediments. *Bull. Environ. Contam. Toxicol.* 52: 691-698.

VIII - APPENDIX

Table II.1: Lake morphometric data for the logged (Cx) and burnt (FBPx or FPx) groups of lakes as of 1995 (Data provided by P. D'Arcy, University of Montreal)

Lake	LA	LP	LS	LV	Zmax	Zmean	SD	Alt	T
C2	0.38	3.73	5.6	1.27	12	3.3	1.70	431	0.76
C9	0.72	8.86	12	4.18	19	5.8	2.95	449	1.16
C12	0.39	4.72	4.2	0.98	5	2.5	2.14	406	0.65
C23	0.30	3.66	4.1	0.66	6	2.2	1.87	394	0.48
C24	0.20	3.83	12	0.70	12	3.4	2.40	411	0.48
C29	0.31	3.33	6.5	1.26	10	4.1	1.68	556	2.63
C40	0.31	5.58	14	2.31	30	7.6	2.85	404	3.43
C44	0.33	3.75	8.3	1.98	19	6.0	1.84	422	1.18
C48	2.38	16.3	3.0	8.48	13	3.6	2.97	491	1.28
FBP9	0.62	10.2	9.5	2.86	20	4.6	3.64	482	0.82
FBP10	0.38	4.22	9.7	2.28	16	6.0	1.93	468	2.57
FP2	0.37	4.84	6.9	1.64	10	4.4	2.23	436	0.93
FP15	0.52	4.44	8.4	3.81	15	7.4	1.74	422	0.33
FP24	0.19	2.90	12	7.95	13	4.2	1.89	455	1.98
FP27	0.66	4.54	9.9	6.63	34	10	1.58	475	5.70
FP30	0.36	3.95	8.5	1.93	13	5.4	1.86	468	0.86
FP31	0.47	3.55	0*	2.49	20	5.3	1.46	497	0.74
FP32	0.31	5.49	8.3	.33	12	4.6	2.77	434	0.70

(* datum for FP31 was not available)

Table II.2: Catchment morphometric data for the logged (Cx) and burnt (FBPx or FPx) groups of lakes as of 1995 (Data provided by P. D'Arcy, University of Montreal)

Lake	CA	WA	WA/LA	CP	DD	CS	LZS	Q	CSL
C2	3.26	2.87	7.5	8.22	3.07	6.99	4.8	1.67	9.99
C9	7.04	6.32	8.8	16.0	1.47	9.73	9.4	3.61	10.3
C12	2.93	2.54	6.6	9.50	1.05	6.34	5.4	1.50	3.09
C23	2.71	2.40	7.9	8.02	1.49	5.76	3.3	1.39	4.03
C24	2.80	2.60	13	7.60	2.13	5.67	8.1	1.44	5.95
C29	0.93	0.62	2.0	4.86	0.13	9.70	6.3	0.48	0.12
C40	1.32	1.01	3.3	5.60	0.44	7.04	9.2	0.68	0.59
C44	3.28	2.95	8.9	7.54	1.08	14.9	6.3	1.68	3.53
C48	12.9	10.6	4.4	18.9	1.74	7.33	3.2	6.64	22.5
FBP9	6.81	6.19	10	15.8	1.95	8.07	6.3	3.49	13.3
FBP10	1.73	1.35	3.6	6.96	0.00	7.58	9.1	0.89	0.00
FP2	3.44	3.07	8.2	8.94	1.78	6.19	6.7	1.77	6.13
FP15	22.2	21.7	42	29.0	1.39	10.1	6.6	11.4	30.8
FP24	0.78	0.59	3.2	4.67	1.04	7.73	8.2	0.40	0.81
FP27	2.27	1.61	2.5	6.74	0.80	12.6	6.9	1.16	1.81
FP30	4.35	3.99	11	9.13	1.39	15.4	8.5	2.23	6.04
FP31	6.98	6.51	14	13	1.56	11.8	0*	3.58	10.9
FP32	2.88	2.56	8.2	9.53	2.13	7.94	13	1.33	6.12

(* datum for FP31 was not available)

Table II.3: Morphometric data for the reference lakes as of 1995 (Data provided by P. D'Arcy, University of Montreal)

Lake	LA	LP	LS	LV	Zmax	Zmean	SD	Alt	T
N5	0.21	3.19	9.5	1.13	14	5.5	1.98	481	0.97
N16	0.86	11.2	8.6	3.98	14	4.7	3.41	489	1.57
N35	0.16	3.73	8.8	4.77	8	2.9	2.60	441	0.66
N43	0.30	3.04	3.7	8.08	9	2.7	1.55	442	0.33
N55	0.28	3.90	4.1	5.99	7	2.1	2.08	410	0.57
N56	0.29	4.22	5.3	0.80	10	2.8	2.22	440	1.17
N59	0.16	2.70	18	0.83	12	5.1	1.89	430	2.68
N63	0.62	4.86	4.1	2.36	10	3.8	1.74	495	1.53
N70	0.66	4.31	6.5	4.51	21	6.8	1.50	435	4.61
N82	0.33	3.40	13	2.80	20	8.4	1.66	473	3.40
N84	0.83	4.41	3.2	3.46	11	4.2	1.37	417	1.86
N88	0.59	5.26	6.2	3.14	13	5.3	1.93	461	1.35
N89	0.70	7.81	6.2	2.87	13	4.1	2.63	446	2.10
N106	0.43	3.36	5.0	1.98	12	4.6	1.44	485	2.19
N107	0.47	3.66	11	4.17	23	8.8	1.50	452	2.00
N120	0.40	3.07	5.0	1.67	11	4.1	1.36	558	2.23
N122	0.21	2.86	6.7	0.68	10	3.3	1.77	436	1.05
P25	0.35	2.87	6.0	1.63	11	4.7	1.38	408	1.74
P109	0.51	6.93	5.3	1.45	10	2.8	2.73	395	1.07
P110	0.84	5.23	3.6	3.86	10	4.6	1.61	391	1.29

Table II.4: Morphometric data for the reference lake catchments as of 1995
(Data provided by P. D'Arcy, University of Montreal)

Lake	CA	WA	WA/LA	CP	DD	CS	LZS	Q	CSL
N5	2.26	2.06	10	10.2	1.84	15.2	8.0	1.16	4.16
N16	4.96	4.10	4.8	15.9	2.13	12.5	8.3	2.54	10.6
N35	1.41	1.25	7.6	6.95	1.02	15.0	8.8	0.72	1.44
N43	4.81	4.51	15	10.4	1.62	4.90	3.0	2.47	7.79
N55	2.04	1.76	6.3	8.03	0.12	8.38	4.1	1.05	0.24
N56	1.34	1.05	3.7	5.33	0.00	7.68	5.3	0.68	0.00
N59	0.60	0.44	2.7	3.39	0.00	12.5	12	0.31	0.00
N63	3.00	2.37	3.8	8.67	1.19	6.24	4.5	1.54	3.56
N70	1.91	1.25	1.9	6.35	0.00	7.60	5.6	0.98	0.00
N82	1.61	1.27	3.8	6.22	0.73	12.1	14	0.82	1.17
N84	3.63	2.80	3.4	10.2	0.35	6.32	3.0	1.86	1.28
N88	4.52	3.93	6.6	12.4	1.67	7.56	6.1	2.32	7.55
N89	2.66	1.96	2.8	8.69	1.47	8.23	7.1	1.36	3.90
N106	1.76	1.33	3.1	6.18	0.88	8.46	4.9	0.91	1.55
N107	4.07	3.59	7.6	8.79	1.50	11.9	8.2	2.10	6.10
N120	1.46	1.06	2.6	6.71	0.77	7.02	4.9	0.75	1.12
N122	1.26	1.05	5.1	5.18	1.31	7.50	5.9	0.65	1.66
P25	1.83	1.48	4.3	6.45	1.16	12.6	7.9	0.94	2.11
P109	2.64	2.13	4.2	7.41	0.42	6.53	3.8	1.35	1.12
P110	5.85	5.02	6.0	10.8	1.45	6.12	4.2	3.00	8.46

Table II.5: Percent of the watersheds logged in 1995
 (Data provided by S. Paquet, GEOTOP/UQAM)

Lake	Percent logged
C2	33.2
C9	45.7
C12	59.6
C23	39.9
C24	38.1
C29	65.1
C40	9.8
C44	7.5
C48	96.4

Table II.6: Percent of the watersheds burnt in 1995
 (Data provided by S. Paquet, GEOTOP/UQAM)

Lake	Percent burnt
FBP9	94.6
FBP10	94.5
FP2	50.1
FP15	98.9
FP24	100
FP27	91.3
FP30	92.2
FP31	100
FP32	100

**Table II.7: Percent of the
forested watersheds
logged as of May 1998
(Data provided by S.
Paquet, GEOTOP/UQAM)**

Lake	Percent logged
C2	73.5
C9	45.7
C12	59.6
C23	39.9
C24	38.1
C29	65.1
C40	9.8
C44	7.5
C48	96.4
N106	27.8
N107	6.2
P25	18.9
P110	20.7

Table IV.1: Abundance, C/N molar ratios, and MeHg contents of SPM collected in September 1997 at one or two depths in the lakes of the logged group (n=14)

Filter	Lake	Sampling depth (m)	SPM (mg/l)	C/N molar ratio	MeHg (nmole/g dw SPM)
L39	C02	7	2.24	10.2	0.16
L57	C09	17	3.25	21.8	1.04
L41	C12	2.5	2.72	10.4	0.42
L5	C23	5	2.88	15.7	1.36
L6	C23	1	8.20	3.6	1.06
L7	C24	7	9.32	18.4	0.46
L8	C24	1	8.02	9.5	1.09
L19	C29	9	2.27	9.1	0.56
L20	C29	1	12.3	11.7	0.56
L10	C40	1	15.6	14.7	0.24
L9	C40	19	3.90	15.8	0.55
L54	C44	15	1.64	11.1	1.14
L21	C48	9	1.62	11.9	0.91
L22	C48	1	11.7	9.3	0.23

Table IV.2: Abundance, C/N molar ratios, and MeHg contents of SPM collected in September 1997 at one or two depths in the lakes of the burnt group (n=12)

Filter	Lake	Sampling depth (m)	SPM (mg/l)	C/N molar ratio	MeHg (nmole/g dw SPM)
L36	FBP09	14	3.39	12.6	0.77
L31	FBP10	9	1.41	10.5	1.21
L32	FBP10	1	5.51	8.2	0.39
L44	FP02	8	15.8	14.0	0.31
L45	FP15	12	1.20	15.1	0.96
L49	FP24	9	2.39	13.2	0.89
L50	FP24	1	7.91	6.5	1.65
L46	FP27	19	1.50	9.6	0.98
L47	FP30	13	3.91	14.2	1.28
L48	FP31	9	1.45	13.1	0.92
L52	FP32	9	4.48	13.5	0.79
L53	FP32	1	7.71	8.0	1.39

Table IV.3: Abundance, C/N molar ratios, and MeHg contents of SPM collected in September 1997 at one or two depths in the reference lakes (n=27)

Filter	Lake	Sampling depth (m)	SPM (mg/l)	C/N molar ratio	MeHg (nmole/g dw SPM)
L56	N16	9	1.54	13.5	1.13
L55	N35	7	2.87	7.4	1.51
L23	N43	8	6.11	19.7	0.37
L24	N43	1	10.4	9.7	0.61
L15	N55	5	2.68	10.9	0.65
L16	N55	1	8.47	10.1	0.39
L42	N59	9	1.28	11.1	0.58
L43	N63	8	3.91	9.9	0.55
L11	N70	19	1.37	16.4	1.15
L12	N70	1	5.56	12.7	0.36
L37	N82	13	1.56	11.7	0.81
L38	N84	8	1.81	10.0	1.10
L29	N88	9	1.42	9.7	0.81
L30	N88	1	4.78	7.8	1.05
L27	N89	8.5	2.25	11.2	1.60
L28	N89	1	5.64	6.9	1.31
L33	N106	8	3.51	11.0	0.53
L34	N106	1	12.6	9.1	0.60
L35	N107	13	1.44	9.7	1.03
L17	N120	9	1.20	12.5	0.89
L18	N120	1	8.11	13.2	1.08
L25	N122	5	3.23	11.1	1.00
L26	N122	1	5.35	8.9	0.64
L40	P25	9	5.72	14.4	0.90
L4	P109	1	32.2	11.8	0.42
L1	P110	8	1.98	17.4	0.54
L2	P110	1	4.51	15.5	1.76

Table IV.4: Dissolved MeHg concentrations (pmole/l) in unfiltered and filtered water column samples collected in September 1997 (n=8)

Lake	Unfiltered	Filtered (measured)	Filtered (calculated)	Group
C44	10.9	27.5	9.0	Logged
FP15	16.3	30.9	15.2	Burnt
FP24	9.7	17.9	7.5	Burnt
FP27	8.9	53.9	7.4	Burnt
FP30	21.2	32.6	16.1	Burnt
FP31	12.8	79.3	11.4	Burnt
N43	5.0		2.7	Reference
N63	31.3		29.2	Reference

Table IV.5. DOC concentrations in mg/l in lake water column samples collected in September 1997 (Data provided by P. D'Arcy, University of Montreal)

Logged		Burnt		Reference	
Lake	DOC	Lake	DOC	Lake	DOC
C2	5.31	FBP9	8.60	N5	7.42
C9	4.16	FBP10	7.27	N16	6.71
C12	3.94	FP2	7.94	N35	8.88
C23	8.44	FP15	10.9	N43	8.06
C24	5.85	FP24	11.9	N55	5.89
C29	5.24	FP27	7.39	N56	3.87
C40	4.63	FP30	3.71	N59	4.87
C44	4.99	FP31	4.09	N63	6.33
C48	5.32	FP32	5.19	N70	5.82
				N82	4.95
				N84	3.42
				N88	5.26
				N89	3.77
				N106	7.25
				N107	6.24
				N120	2.71
				N122	6.01
				P25	4.62
				P109	5.42
				P110	3.96

Table IV.6: Chemical parameters - means and their standard errors (shown in parentheses) - of the water samples collected in September 1997 (Data provided by P. D'Arcy, University of Montreal)

	Logged	Burnt	Reference
Sodium (mg/l)	0.75 (0.02)	0.67 (0.01)	0.62 (0.01)
Potassium (mg/l)	1.61 (0.03)	2.06 (0.06)	1.52 (0.02)
Calcium (mg/l)	0.43 (0.01)	0.70 (0.01)	0.42 (0.01)
Magnesium (mg/l)	0.51 (0.09)	0.74 (0.01)	0.22 (0.10)
Chloride ($\mu\text{g/l}$)	0.19 (0.01)	0.30 (0.01)	0.13 (0.00)
Sulfate (mg/l)	0.80 (0.01)	1.42 (0.02)	0.84 (0.01)
Total phosphorus ($\mu\text{g/l}$)	8.64 (0.25)	9.95 (0.25)	5.82 (0.09)
Total nitrogen ($\mu\text{g/l}$)	223 (6)	281 (7)	193 (0.3)
Ammonium ($\mu\text{g/l}$)	7.74 (0.51)	9.24 (0.45)	4.86 (0.09)
Nitrate ($\mu\text{g/l}$)	3.4 (0.3)	25.6 (3.7)	1.7 (0.07)
Hydrogen ion ($\mu\text{eq/l}$)	0.79 (0.06)	0.54 (0.07)	0.74 (0.02)

Table IV.7: Dissolved MeHg concentrations in filtered water samples of May 1998

	Logged			Burnt			Reference	
Lake	MeHg (pmole/l)	% Error	Lake	MeHg (pmole/l)	% Error	Lake	MeHg (pmole/l)	% Error
C2	68.3	1.7	FBP9	6.5	1.9	N5	3.4	3.2
C12	19.9	11.1	FBP10	4.4	19.8	N43	3.2	0.8
C23	5.0	13.1	FP2	14.1	11.5	N55	41.5	1.5
C24	8.9	3.8	FP15	6.3	9.3	N56	5.4	11.7
C29	7.3	8.5	FP24	7.5	6.5	N59	2.5	6.6
C40	45.5	2.2	FP27	9.1	0.4	N63	14.4	4.2
C44	5.3	8.2	FP30	1.6	9.5	N70	24.7	7.4
C48	5.1	2.2	FP31	10.8	1.0	N82	223	4.6
N106	19.3	11.8	FP32	22.9	3.0	N84	113	4.3
N107	40.7	3.5				N88	1.6	6.4
P25	29.3	5.8				N89	15.8	1.4
P110	19.0	15.1				N120	2.8	3.0
						N122	2.1	13.5
						P109	8.7	8.9

Table IV.8: DOC concentrations in mg/l in lake water column samples collected in May 1998 (Data provided by P. D'Arcy, University of Montreal)

Logged		Burnt		Reference	
Lake	DOC	Lake	DOC	Lake	DOC
N106	6.73	FP2	9.09	N5	4.98
N107	5.70	FP15	7.23	N43	8.66
P25	4.11	FP24	4.64	N55	5.52
P110	4.13	FP27	2.86	N56	4.86
C2	7.68	FP30	6.82	N59	4.31
C9	5.76	FP31	5.53	N63	5.08
C12	9.12	FP32	6.05	N70	5.18
C23	11.1	FBP9	8.85	N82	4.50
C24	11.0	FBP10	3.61	N84	3.22
C29	2.61			N88	5.09
C40	3.80			N89	3.51
C44	4.07			N120	2.35
C48	6.67			N122	5.66
				P109	5.75

Table IV.9: Chemical parameters - means and their standard errors (shown in parentheses) - of the water samples collected in May 1998 (Data provided by P. D'Arcy, University of Montreal)

	Logged	Burnt	Reference
Sodium (mg/l)	0.76 (0.02)	0.67 (0.01)	0.64 (0.01)
Potassium (mg/l)	1.67 (0.03)	2.06 (0.06)	1.49 (0.03)
Calcium (mg/l)	0.43 (0.01)	0.67 (0.01)	0.41(0.01)
Magnesium (mg/l)	0.45 (0.02)	0.70 (0.02)	0.22 (0.01)
Chloride (µg/l)	0.20 (0.01)	0.23 (0.01)	0.15 (0.00)
Sulfate (mg/l)	0.79 (0.02)	1.19 (0.02)	0.74 (0.01)
Total phosphorus (µg/l)	9.61 (0.33)	14.79 (0.77)	7.72 (0.13)
Total nitrogen (µg/l)	235 (4.1)	304 (11.8)	215 (3.7)
Ammonium (µg/l)	8.64 (0.20)	12.98 (0.64)	7.57 (0.23)
Nitrate (µg/l)	12.7 (1.0)	29.8 (4.1)	10.1 (1.2)
Hydrogen ion (µeq/l)	0.71 (0.03)	0.60 (0.06)	0.77 (0.03)

Table IV.10: Total mercury concentrations (nmole/g dw) and C/N molar ratios of the surficial bottom sediments collected in the logged and burnt groups of lakes in July 1997 (Data provided by Dr. B. Quémerais and B. Fortin, Centre Saint-Laurent, and L. Courmoyer, GEOTOP/UQAM)

	Logged				Burnt		
Lake	Total Hg	C/N ratio	Depth (m)	Lake	Total Hg	C/N ratio	Depth (m)
C2	0.04	23.2	10	FBP9	0.17	21.1	17
C9	0.08	15.6	19	FBP10	0.16	12.7	15.5
C12	0.1	27.7	3.5	FP2	0.10	18.4	10
C23	0.05	24.8	5.5	FP15	0.15	19.6	14.5
C24	0.41	19.1	10	FP24	0.11	17.4	11
C29	0.01	18.5	6.5	FP30	0.14	15.6	13.5
C40	0.02	10.8	30	FP31	0.15	13.4	15
C44	0.04	18.6	11	FP32	0.11	19	10.5
C48	0.11	15.9	7				

Table IV.11: Total mercury concentrations (nmole/g dw) and C/N molar ratios of the surficial bottom sediments collected in the reference lakes in July 1997 (Data by Dr. A. Quémerais and B. Fortin, Centre Saint-Laurent, and L. Courmoyer, GEOTOP/UQAM)

Lake	Total Hg	C/N ratio	Depth (m)
P25	0.10	16.1	10
P109	0.10	16.7	10
P110	0.06	19.7	6
N5	0.12	19.8	12
N16	0.14	16.8	14
N35	0.07	19.1	6.5
N43	0.09	21.6	8.5
N55	0.07	16.7	6.5
N56	0.06	16	6
N59	0.08	16.2	8
N63	0.10	16.8	10
N70	0.19	17.3	19
N82	0.18	18	18
N84	0.10	15.7	10
N88	0.10	9.3	9.5
N89	0.13	13.9	13.4
N106	0.10	17.7	10
N107	0.15	18.5	15
N120	0.12	14.8	11.5
N122	0.07	17.2	7

Table IV.12: Pearson's determination coefficients (r) between the concentrations of MeHg in the SPM sampled in September 1997 and morphometric parameters (statistically significant coefficients in bold characters).

Parameters	All lakes (n=52)	Logged (n=14)	Burnt (n=11)	Reference (n=27)
Lake altitude	-0.034	-0.224	0.030	0.037
Watershed area	0.003	0.02	-0.074	0.113
Watershed area/Lake area	-0.017	0.335	-0.102	-0.155
Drainage density	0.139	0.021	0.132	0.308
Water flow	0.000	-0.006	-0.077	0.155
Lake area	-0.038	-0.118	-0.293	0.340
Lake perimeter	-0.028	-0.123	-0.298	0.361
Lake mean slope	0.055	-0.078	0.401	0.058
Latitude (decimal form)	-0.071	-0.107	-0.213	0.103
Mean littoral slope	0.175	-0.136	0.243	0.205
Longitude (decimal form)	-0.006	-0.228	-0.180	0.130
Lake maximum depth	-0.033	-0.231	-0.013	0.105
Lake mean depth	0.070	-0.203	-0.039	0.155
Lake water residence time	-0.031	-0.401	0.024	0.077
Shore density	0.013	-0.156	-0.176	0.293
Catchment stream length	0.002	-0.048	-0.063	0.218
Sampling depth	0.057	0.225	-0.135	0.044
Sum of wetland areas	0.034	0.133	0.017	0.066
Catchment area	0.000	-0.006	-0.077	0.155
Catchment perimeter	0.070	0.074	-0.133	0.281
Mean catchment slope	0.251	0.298	0.137	0.180
Lake volume	0.025	-0.129	-0.136	0.315

Table IV.13: Pearson's determination coefficients (r) between morphometric parameters and the concentrations of dissolved MeHg in the water sampled in May 1998 (statistically significant coefficients in bold characters).

Parameters	All lakes (n=34)	Logged (n=12)	Burnt (n=8)	Reference (n=14)
Lake altitude	-0.070	-0.206	-0.509	-0.026
Catchment area	-0.124	-0.227	-0.196	-0.071
Catchment area/Lake area	-0.143	-0.096	-0.106	-0.167
Drainage density	-0.049	0.466	0.544	-0.145
Water flow	-0.117	-0.233	-0.203	-0.030
Lake area	-0.013	-0.244	-0.303	0.147
Lake perimeter	-0.117	-0.239	-0.075	-0.111
Mean lake slope	0.148	0.296	-0.359	0.231
Latitude (decimal form)	0.030	-0.119	-0.372	0.022
Mean littoral slope	0.337	0.333	0.570	0.475
Longitude (decimal form)	0.086	-0.161	-0.309	0.193
Lake maximum depth	0.183	0.400	-0.184	0.483
Lake mean depth	0.295	0.344	-0.218	0.576
Lake water residence time	0.219	0.209	-0.099	0.376
Shore density	-0.204	-0.157	0.171	-0.290
Watershed stream length	-0.141	-0.042	-0.126	-0.209
Sum of wetland areas	-0.180	-0.212	-0.031	-0.246
Watershed area	-0.117	-0.233	-0.203	-0.043
Watershed perimeter	-0.117	-0.228	-0.171	-0.043
Mean watershed slope	0.101	0.013	-0.474	0.247
Lake volume	0.083	-0.127	-0.219	0.358

Table IV.14: Pearson's determination coefficients (r) between morphometric parameters and the concentrations of total Hg in the bottom sediments sampled in July 1997 (statistically significant coefficients in bold characters).

Parameters	All lakes (n=37)	Logged (n=9)	Burnt (n=8)	Reference (n=20)
Lake altitude	-0.271	-0.238	-0.644	-0.295
Watershed area	0.014	0.099	0.897	-0.168
Watershed area/Lake area	0.076	0.709	0.801	-0.078
Drainage density	-0.032	0.297	0.278	-0.101
Water flow	0.013	0.075	0.890	-0.162
Lake area	-0.049	-0.034	0.147	-0.107
Lake perimeter	-0.077	-0.001	-0.007	-0.115
Mean lake slope	-0.152	0.244	-0.603	-0.195
Latitude (decimal form)	0.256	0.260	-0.337	0.290
Mean littoral slope	-0.218	0.215	-0.301	-0.270
Longitude (decimal form)	-0.053	-0.290	-0.424	0.026
Lake maximum depth	-0.223	-0.186	-0.336	-0.248
Lake mean depth	-0.277	-0.267	0.061	-0.321
Lake water residence time	-0.248	-0.463	-0.588	-0.257
Shore density	-0.047	0.220	-0.126	-0.048
Catchment stream length	-0.030	0.134	0.880	-0.235
Sum of wetland areas	-0.013	0.042	0.815	-0.117
Catchment area	0.013	0.075	0.890	-0.162
Catchment perimeter	-0.039	0.073	0.853	-0.220
Mean catchment slope	-0.199	-0.383	0.014	-0.250
Lake volume	-0.161	-0.090	0.037	-0.249

Table IV.15. Pearson's determination coefficients (r) between the dissolved MeHg concentrations and chemical parameters in the water column sampled in May 1998 (statistically significant coefficients in bold characters).

Chemical parameters	All lakes (n=33)	Logged (n=12)	Burnt (n=9)	Reference (n=12)
Alkalinity	0.002	-0.113	-0.197	0.303
Calcium	0.095	0.077	-0.238	0.521
Chlorophyll-a	-0.108	-0.413	-0.093	0.690
Chloride	-0.023	-0.280	-0.038	0.198
DOC	0.013	-0.129	0.107	0.017
Hydrogen ion	-0.001	0.073	0.255	-0.220
Potassium	-0.087	-0.144	-0.512	0.031
Magnesium	-0.170	-0.003	-0.005	-0.078
Sodium	0.173	-0.079	0.264	0.264
Total nitrogen	-0.084	-0.202	0.318	-0.253
Ammonium (NH ₄ ⁺)	-0.133	-0.082	0.024	-0.153
Nitrate (NO ₃ ⁻)	-0.107	-0.035	-0.157	0.305
pH	0.034	-0.020	-0.250	-0.367
Secchi depth	-0.079	0.106	-0.045	0.155
Sulfate	0.019	0.349	0.186	0.195
Total phosphorus	-0.044	-0.141	0.404	0.201

Table V.1: Partition coefficients (K_d) of MeHg between the SPM and the dissolved phase (i.e., <0.3 μm) for seven lakes sampled in September 1997

Lake	Group	K _d (10 ⁴)
C44	Logged	4.2
FP2	Burnt	2.1
FP15	Burnt	3.1
FP24	Burnt	5.0
FP27	Burnt	1.8
FP30	Burnt	3.9
FP31	Burnt	1.2